

HD VIDEO SWITCHER V-1HD



Owner's Manual



Owner's Manual (this document)

Read this first. It explains the basic things you need to know in order to use the V-1HD.



PDF Manual (download from the Web)

- **Remote Control Guide**
This manual covers remote control of the V-1HD via MIDI.
- **V-1HD RCS Owner's Manual**
This is the manual for V-1HD RCS dedicated remote-control software for the V-1HD.



To obtain the PDF manual

1. Enter the following URL in your computer.
<http://proav.roland.com>
2. Go to the V-1HD product page and click the "Support" tab.

Copyright © 2015 ROLAND CORPORATION

Before using the V-1HD, ensure that its system program is at the most recent version. For information on available upgrades for the system program, see the Roland website (<http://proav.roland.com>). You can check the system program version by pressing and holding the [(TAP) BPM] button → "VERSION" at the SETUP menu.

Contents

USING THE UNIT SAFELY	3
IMPORTANT NOTES	5
Panel Descriptions	6
Top Panel/Front Panel	6
Rear Panel (for Equipment Connections)	8
Side Panel (for Equipment Connections).....	10
Basic Operation	11
Turning the Power On and Off	11
Turning Off the Power Automatically (Auto Off)	11
Using the Menus.....	12
Saving/Recalling Settings (Memory)	13
Video Input/Output Settings	14
Setting the Video Input/Output Format	14
Adjusting Output Video.....	14
Switching the View Mode of Preview Output....	15
Inputting Copyright-protected (HDCP) Video ...	15
Video Operations	16
Switching the Video	16
Switching Using the A/B Fader	16
Switching Using the TRANSFORMER Buttons..	17
Switching in Time with Music (BPM Sync).....	18
Switching Automatically (Auto Scan).....	19
Using a Different Transition Pattern.....	19
Applying a Fade to the Main Output Video (Output Fade).....	20
Freezing Input Video (Freeze)	20

Video Effect Operations	21
Using Filter Effects	21
Selecting a Filter Effect.....	21
Applying Filter Effects	21
Using Compositing Effects	22
Selecting a Compositing Effect.....	22
Compositing Using Luminance Key.....	22
Compositing Using Chroma Key.....	23
Compositing Using Picture-in-Picture	23
Compositing Using Split	24
Audio Operations	25
Adjusting the Volume Level	25
Applying Effects to Audio	26
Applying Effects to Input Audio	26
Applying Effects to Output Audio	27
Interlinking Audio Output to Video Switching (Audio Follow) ..	28
Other Features	29
Returning Settings to the Factory- default State (Factory Reset).....	29
Operating the V-1HD by Remote Control	29
Appendices	30
Troubleshooting	30
Menu List	31
MEMORY Menu.....	31
AUDIO Menu	32
SETUP Menu	33
Transition Effects List	35
Block Diagram.....	36
Main Specifications	38
Dimensions	40

Before using this unit, carefully read "USING THE UNIT SAFELY" (p. 3) and "IMPORTANT NOTES" (p. 5). After reading, keep the document(s) including those sections where it will be available for immediate reference.

Checking the Included Items

The V-1HD includes the following items. Please take a moment to confirm that all of these items have been included with the V-1HD. If you find that any item is missing, contact the nearest authorized Roland distributor in your country.

The Unit



AC Adaptor/Power Cord



Cord Hook



Owner's Manual





* The shape of the power cord's plug varies depending on the country.







USING THE UNIT SAFELY

INSTRUCTIONS FOR THE PREVENTION OF FIRE, ELECTRIC SHOCK, OR INJURY TO PERSONS

About WARNING and CAUTION Notices

 WARNING	Used for instructions intended to alert the user to the risk of death or severe injury should the unit be used improperly.
 CAUTION	Used for instructions intended to alert the user to the risk of injury or material damage should the unit be used improperly. * Material damage refers to damage or other adverse effects caused with respect to the home and all its furnishings, as well to domestic animals or pets.

About the Symbols

	The  symbol alerts the user to important instructions or warnings. The specific meaning of the symbol is determined by the design contained within the triangle. In the case of the symbol at left, it is used for general cautions, warnings, or alerts to danger.
	The  symbol alerts the user to items that must never be carried out (are forbidden). The specific thing that must not be done is indicated by the design contained within the circle. In the case of the symbol at left, it means that the unit must never be disassembled.
	The  symbol alerts the user to things that must be carried out. The specific thing that must be done is indicated by the design contained within the circle. In the case of the symbol at left, it means that the power-cord plug must be unplugged from the outlet.

ALWAYS OBSERVE THE FOLLOWING

WARNING

To completely turn off power to the unit, pull out the plug from the outlet

Even with the power switch turned off, this unit is not completely separated from its main source of power. When the power needs to be completely turned off, turn off the power switch on the unit, then pull out the plug from the outlet. For this reason, the outlet into which you choose to connect the power cord's plug should be one that is within easy reach and readily accessible.



Concerning the Auto Off function

On this unit, the power is automatically turned off after a predetermined amount of time has passed since an operation was performed (Auto Off function).

If you do not want the power to be turned off automatically, disengage the Auto Off function (p. 11).



Do not disassemble or modify by yourself

Do not carry out anything unless you are instructed to do so in the owner's manual. Otherwise, you risk causing malfunction.



Do not repair or replace parts by yourself

Refer all servicing to your retailer, the nearest Roland Service Center, or an authorized Roland distributor, as listed on the "Information."





Do not place in an unstable location

Otherwise, you risk injury as the result of the unit toppling over or dropping down.



WARNING

Do not use or store in the following types of locations

- Subject to temperature extremes (e.g., direct sunlight in an enclosed vehicle, near a heating duct, on top of heat-generating equipment); or are 
- Damp (e.g., baths, washrooms, on wet floors); or are 
- Exposed to steam or smoke; or are
- Subject to salt exposure; or are
- Exposed to rain; or are
- Dusty or sandy; or are
- Subject to high levels of vibration and shakiness; or are
- Placed in a poorly ventilated location.

Use only the supplied AC adaptor and the correct voltage

Be sure to use only the AC adaptor supplied with the unit. Also, make sure the line voltage at the installation matches the input voltage specified on the AC adaptor's body. Other AC adaptors may use a different polarity, or be designed for a different voltage, so their use could result in damage, malfunction, or electric shock.



Use only the supplied power cord

Use only the attached power cord. Also, the supplied power cord must not be used with any other device.



Do not bend the power cord or place heavy objects on it

Otherwise, fire or electric shock may result.



Avoid extended use at high volume

Use of the unit at high volume for extended periods of time may cause hearing loss. If you ever experience any hearing loss or ringing in the ears, you should immediately stop using the unit and consult a specialized physician.



USING THE UNIT SAFELY

WARNING

Do not allow foreign objects or liquids to enter unit; never place containers with liquid on unit

Do not place containers containing liquid (e.g., flower vases) on this product. Never allow foreign objects (e.g., flammable objects, coins, wires) or liquids (e.g., water or juice) to enter this product. Doing so may cause short circuits, faulty operation, or other malfunctions.



Turn off the unit if an abnormality or malfunction occurs

Immediately turn the unit off, remove the AC adaptor from the outlet, and request servicing by your retailer, the nearest Roland Service Center, or an authorized Roland distributor, as listed on the "Information" when:



- The AC adaptor or the power cord has been damaged; or
- If smoke or unusual odor occurs; or
- Objects have fallen into, or liquid has been spilled onto the unit; or
- The unit has been exposed to rain (or otherwise has become wet); or
- The unit does not appear to operate normally or exhibits a marked change in performance.

Be cautious to protect children from injury

Always make sure that an adult is on hand to provide supervision and guidance when using the unit in places where children are present, or when a child will be using the unit.



Do not drop or subject to strong impact

Otherwise, you risk causing damage or malfunction.



Do not share an outlet with an unreasonable number of other devices

Otherwise, you risk overheating or fire.



Do not use overseas

Before using the unit in overseas, consult with your retailer, the nearest Roland Service Center, or an authorized Roland distributor, as listed on the "Information."



CAUTION

When disconnecting the power cord, grasp it by the plug

To prevent conductor damage, always grasp the power cord by its plug when disconnecting it from this unit or from a power outlet.



Periodically clean the power plug

An accumulation of dust or foreign objects between the power plug and the power outlet can lead to fire or electric shock.



At regular intervals, be sure to pull out the power plug, and using a dry cloth, wipe away any dust or foreign objects that may have accumulated.

CAUTION

Disconnect the power plug whenever the unit will not be used for an extended period of time

Fire may result in the unlikely event that a breakdown occurs.



Route all power cords and cables in such a way as to prevent them from getting entangled

Injury could result if someone were to trip on a cable and cause the unit to fall or topple.



Avoid climbing on top of the unit, or placing heavy objects on it

Otherwise, you risk injury as the result of the unit toppling over or dropping down.



Never connect/disconnect a power plug if your hands are wet

Otherwise, you could receive an electric shock.



Disconnect all cords/cables before moving the unit

Before moving the unit, disconnect the power plug from the outlet, and pull out all cords from external devices.



Before cleaning the unit, disconnect the power plug from the outlet

If the power plug is not removed from the outlet, you risk receiving an electric shock.



Whenever there is a threat of lightning, disconnect the power plug from the outlet

If the power plug is not removed from the outlet, you risk receiving an electric shock.



Keep small items out of the reach of children

To prevent accidental ingestion of the parts listed below, always keep them out of the reach of small children.

- Included Parts: Cord hook (p. 10)
- Removable Parts: Screw (p. 10)



Handle the ground terminal carefully

If you remove the screw from the ground terminal, be sure to replace it; don't leave it lying around where it could accidentally be swallowed by small children. When refastening the screw, make that it is firmly fastened, so it won't come loose.



IMPORTANT NOTES

Power Supply

- Do not connect this unit to same electrical outlet that is being used by an electrical appliance that is controlled by an inverter or a motor (such as a refrigerator, washing machine, microwave oven, or air conditioner). Depending on the way in which the electrical appliance is used, power supply noise may cause this unit to malfunction or may produce audible noise. If it is not practical to use a separate electrical outlet, connect a power supply noise filter between this unit and the electrical outlet.
- The AC adaptor will begin to generate heat after long hours of consecutive use. This is normal, and is not a cause for concern.

Placement

- Using the unit near power amplifiers (or other equipment containing large power transformers) may induce hum. To alleviate the problem, change the orientation of this unit; or move it farther away from the source of interference.
- This unit may interfere with radio and television reception. Do not use this unit in the vicinity of such receivers.
- Noise may be produced if wireless communications devices, such as cell phones, are operated in the vicinity of this unit. Such noise could occur when receiving or initiating a call, or while conversing. Should you experience such problems, you should relocate such wireless devices so they are at a greater distance from this unit, or switch them off.
- When moved from one location to another where the temperature and/or humidity is very different, water droplets (condensation) may form inside the unit. Damage or malfunction may result if you attempt to use the unit in this condition. Therefore, before using the unit, you must allow it to stand for several hours, until the condensation has completely evaporated.
- Depending on the material and temperature of the surface on which you place the unit, its rubber feet may discolor or mar the surface.
- Do not place containers or anything else containing liquid on top of this unit. Also, whenever any liquid has been spilled on the surface of this unit, be sure to promptly wipe it away using a soft, dry cloth.

Maintenance

- Never use benzine, thinners, alcohol or solvents of any kind, to avoid the possibility of discoloration and/or deformation.

Repairs and Data

- Before requesting servicing, back up the data stored in the unit by writing down the stored information or by using V-1HD RCS dedicated software (p. 29). Although we will do our utmost to preserve the data stored in your unit when we carry out repairs, in some cases, such as when the memory section is physically damaged, restoration of the stored content may be impossible. Roland assumes no liability concerning the restoration of any stored content that has been lost.

Additional Precautions

- Any data stored within the unit can be lost as the result of equipment failure, incorrect operation, etc. To protect yourself against the irretrievable loss of important data stored in the unit, use V-1HD RCS dedicated software (p. 29) to make backups.
- Roland assumes no liability concerning the restoration of any stored content that has been lost.
- Use a reasonable amount of care when using the unit's buttons, sliders, or other controls; and when using its jacks and connectors. Rough handling can lead to malfunctions.
- When disconnecting all cables, grasp the connector itself—never pull on the cable. This way you will avoid causing shorts, or damage to the cable's internal elements.
- To avoid disturbing others nearby, try to keep the unit's volume at reasonable levels.
- This unit allows you to switch images at high speed. For some people, viewing such images can cause headache, nausea, or other discomfort. Do not use this unit to create video that might cause these types of health problems. Roland Corporation will accept no responsibility for any such health problems that may occur in yourself or in viewers.
- Do not use connection cables that contain a built-in resistor.

Panel Descriptions

Top Panel/Front Panel

[OUTPUT FADE] Knob p. 20

This performs a fade-in or fade-out for the output video.

Turning the control clockwise applies a white fade. Turning it counterclockwise applies a black fade.

The indicators on the left and right of the [OUTPUT FADE] knob show the status of the fade.

Flashing	Fade-in/fade-out in progress
Dark	Normal output

[FREEZE] Button p. 20

This stops (freezes) input video. The [FREEZE] button lights up during a freeze.

[(TAP) BPM] Button p. 12, 18

This sets the BPM (tempo) according to the timing with which you tap the [(TAP) BPM] button. The indicator above the [(TAP) BPM] button flashes in sync with the current BPM setting.

- Pressing and holding the [(TAP) BPM] button (for 2 seconds or longer) to turn it on (lighted) displays the SETUP menu on the monitor connected to the PREVIEW connector.

[AUDIO] Button p. 12, 25

Turning this on (lighted) displays the AUDIO menu on the monitor connected to the PREVIEW connector.

The [A-1] through [A-4] and [B-1] through [B-4] buttons function as shortcut selection buttons for the AUDIO menu.

Button	AUDIO Menu
[A-1]	HDMI IN 1 LEVEL
:	:
[A-4]	HDMI IN 4 LEVEL
[B-1]	AUDIO IN LEVEL
[B-2]	MIC LEVEL
[B-3]	MASTER OUT LEVEL
[B-4]	AUDIO FOLLOW

EFFECTS A/EFFECTS B [ON] Buttons p. 21

These turn effects on and off for the respective output video on bus A and bus B. When turned on, the [ON] button lights up.

[EFFECTS A] and [EFFECTS B] Knobs p. 21

When an effect is on, these adjust the degree of effect applied.



[MEMORY] Button p. 12, 13

This turns the memory function on and off. When this is turned on (lighted), you can save and recall up to eight types of settings, including video and audio settings and operation-panel states.

The [A-1] through [A-4] and [B-1] through [B-4] buttons function as memory selection buttons 1 through 8.

- Turning on the memory function displays the MEMORY menu on the monitor connected to the PREVIEW connector.

HDCP Indicator p. 15

This lights up, flashes, or goes dark according to HDCP (digital content protection) settings and the connection status of HDCP-compatible equipment.

[BPM SYNC] Button p. 18

This turns the BPM sync function on and off. When this is turned on (lighted), the video on bus A and bus B is switched in synchronization with the BPM setting.

A/B Fader p. 12, 16

This functions as a T-Bar video fader. This performs switching between the bus A video and the bus B video.

- When a menu is displayed, this changes setting values.

TRANSFORMER [▲] and [▼] Buttons p. 12, 17

These perform the operations assigned to the buttons, such as switching between the bus A video and the bus B video, without using the A/B fader.

- When a menu is displayed, these select menu items.

Cooling-fan Xhaust Port



This expels internal heat to keep temperatures inside the V-1HD cool.

NOTE Never obstruct the cooling-fane xhaust port. Obstructing the xhaust port might result in a temperature rise inside the V-1HD and lead to malfunction due to heat.

[A-1]–[A-4] Buttons p. 16

These select the video to input to bus A of the video mixer. The selected button lights up.

[B-1]–[B-4] Buttons p. 16

These select the video to input to bus B of the video mixer. The selected button lights up.

[WIPE], [MIX], and [CUT] Buttons p. 16

These select video transition effects. The selected button lights up.

[WIPE]	The original video is broken into by the next video.
[MIX]	As the original picture gradually disappears, the next video is overlaid and progressively grows more visible.
[CUT]	The picture switches instantly.

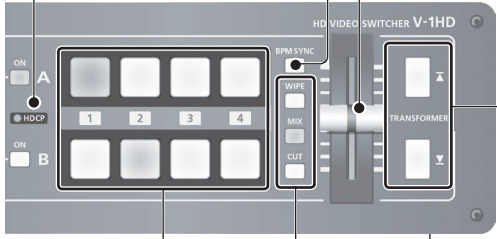

Rear Panel (for Equipment Connections)

- * To prevent malfunction and equipment failure, always turn down the volume, and turn off all the units before making any connections.
- * Be sure to use cables and adaptor plugs with the proper connectors matching those of the other devices you are using.

USB Port p. 29

You use V-1HD RCS dedicated software to operate the V-1HD remotely from a connected computer or tablet.

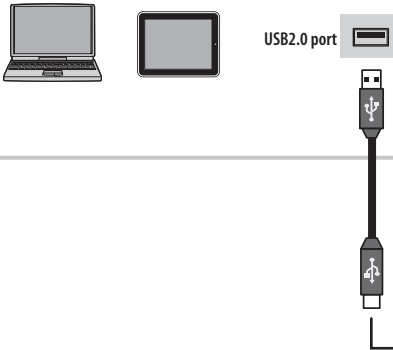

USB2.0 port

OUTPUT Connector

This outputs the video mixing result (main output video). Here you can connect a device such as an external display or projector.

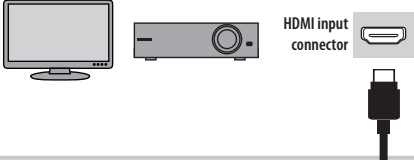

HDMI input connector

[FORMAT] Switch p. 14

This switches the input/output format.

- * Before setting the input/output format, first be sure to turn off the power to the V-1HD.

DC IN Connector

This is for connecting the included AC adaptor.

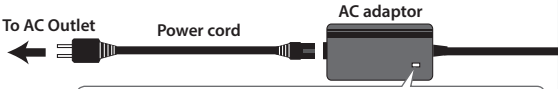

To AC Outlet Power cord AC adaptor

Place the AC adaptor so the side with the indicator faces upwards and the side with printed information faces downwards. The indicator will light when you plug the AC adaptor into an AC outlet.

- * To prevent the inadvertent disruption of power to your unit (should the plug be pulled out accidentally), and to avoid applying undue stress to the jack, anchor the power cord using the cord hook, as shown in the illustration.



Cord hook

For information on how to attach the cord hook, refer to "Attaching the Power Cord Hook" (p. 10).



FORMAT DC IN POWER USB OUTPUT

1080i 1080p 720p

1080p 720p

[POWER] Button p. 11

This turns the power on and off.

* The V-1HD is designed to radiate heat from the entire rear panel. Accordingly, the rear panel might become hot during use, but this is not a malfunction.

PREVIEW Connector

p. 15

This outputs the incoming video on channels 1 through 4 as a four-way split screen. You connect a preview monitor here.



* Alternatively, you can display only the video currently being output (the same video sent via the OUTPUT connector), or only the video to be output next.

HDMI INPUT Connectors

Here you input video signals from video cameras, Blu-ray Disc players, or other video equipment and computers.



AUDIO OUT Jacks

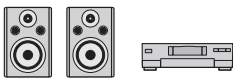

Audio input connectors

These output the results of the audio mix. Here you connect an audio recording deck, amplifier, speakers, or other such equipment. These accept RCA phono type plugs.

AUDIO IN Jacks



Audio output connectors

These are for incoming audio signals from an audio mixer, portable music players, or other audio or video equipment. These accept RCA phono type plugs.

Side Panel (for Equipment Connections)

MIC Jack

Here is where you connect a microphone. This accepts a miniature stereo phone plug. You can also use plug-in-power microphones.



PHONES Jack

This is for connecting headphones. This accepts a miniature stereo phone plug.



[MIC] Knob

This adjusts microphone input sensitivity.

[PHONES] Knob

This adjusts the volume level for headphones.

MIDI OUT/THRU Connector, MIDI IN Connector p. 29

Here you connect a MIDI device used for remote control.

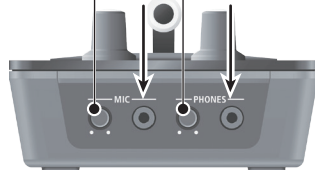
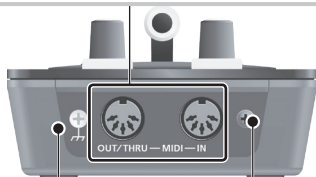

Grounding Terminal

Depending on the circumstances of a particular setup, you may experience a discomforting sensation, or perceive that the surface feels gritty to the touch when you touch this device, microphones connected to it, or the metal portions of other objects, such as guitars. This is due to an infinitesimal electrical charge, which is absolutely harmless. However, if you are concerned about this, connect the ground terminal with an external ground. When the unit is grounded, a slight hum may occur, depending on the particulars of your installation. If you are unsure of the connection method, contact the nearest Roland Service Center, or an authorized Roland distributor, as listed on the "Information."

Unsuitable places for connection

- Water pipes (may result in shock or electrocution)
- Gas pipes (may result in fire or explosion)
- Telephone-line ground or lightning rod (may be dangerous in the event of lightning)

Attaching the Power Cord Hook

1. Detach the retainer screw indicated in the figure.

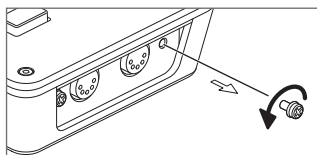

2. Clamp the power cord with the power-cord hook as shown in the figure and secure in place using the screw you removed in step 1.

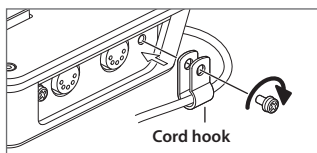

Basic Operation

Turning the Power On and Off

Once everything is properly connected (p. 8–10), be sure to follow the procedure below to turn on their power. If you turn on equipment in the wrong order, you risk causing malfunction or equipment failure.

- * Before turning the unit on/off, always be sure to turn the volume down. Even with the volume turned down, you might hear some sound when switching the unit on/off. However, this is normal and does not indicate a malfunction.

Turning the Power On

1. Make sure all devices are turned off.
2. Press the [POWER] button on the rear panel of the V-1HD to turn on the power.



- * This unit is equipped with a protection circuit. A brief interval (a few seconds) after turning the unit on is required before it will operate normally.

3. Turn on the power for the source devices.
Turn on the power to video cameras or other source equipment connected to input connectors on the V-1HD.
4. Turn on the power for the output devices.
Turn on the power to projectors or other devices connected to output connectors on the V-1HD.

Turning the Power Off

1. Turn off the power in the sequence of first the output equipment, and then the sources.
2. Press the [POWER] button on the V-1HD to turn off the power.

MEMO

- The power to the V-1HD turns off automatically if a set interval elapses with no operation performed (Auto Off function).
If you don't want the power to be turned off automatically, disengage the Auto Off function. For details, refer to "Turning Off the Power Automatically (Auto Off)" on this page.

Turning Off the Power Automatically (Auto Off)

Auto Off is a feature that automatically turns off the power after no operation for a specific period of time. This helps prevent wasting electrical power. By factory default, the Auto Off function is set on. When the states described below persist for 240 minutes, the Auto Off function acts to automatically turn off the power.

- No operation performed on the V-1HD
- No audio or video input

To turn the Auto Off function off or on, follow the steps below to change the setting.

MEMO

- When the power has been turned off by the Auto Off function, to restart, first press the [POWER] button to return it to the Off position, then turn on the power.

1. Press and hold the [(TAP) BPM] button (for 2 seconds or longer) to display the SETUP menu.
2. Use the [▲] and [▼] buttons to select "AUTO OFF:"

[SETUP]	Page 6
MIX TYPE CHANGE	= ON
AUTO OFF	= ON
FRAME RATE	= 59.94
FACTORY RESET	= ---
VERSION	1.00

3. Use the A/B fader to set the Auto Off function on or off.

Value	Explanation
ON	The Auto Off function is turned on. Power is turned off automatically.
OFF	The Auto Off function is turned off. Power is not turned off automatically.

4. Press the [(TAP) BPM] button to quit the menu.

NOTE

- Any settings that you are in the process of editing will be lost when the power is turned off. If you have any settings that you want to keep, you should save them beforehand.

Executing/Changing Specific Functions at Startup

You can execute or change the following functions at startup of the V-1HD.

Operation at startup	Operation
Returning settings to the factory-default state at startup (p. 29)	Hold down the [▲] and [▼] buttons and press the [POWER] button.
Setting "HDCP" on the SETUP menu to "ON" at startup (p. 15)	Hold down the EFFECTS A [ON] button and press the [POWER] button.
Setting "HDCP" on the SETUP menu to "OFF" at startup (p. 15)	Hold down the EFFECTS B [ON] button and press the [POWER] button.

Using the Menus

This explains how to display menus and make settings for video and audio, and for the V-1HD itself.

* The menu is shown on the monitor connected to the PREVIEW connector (p. 9).

NOTE

- Video-switching operations cannot be performed while a menu is displayed.

Displaying/Exiting Menus

The V-1HD has three types of menus (SETUP, MEMORY, and AUDIO).

The "MEMORY = 1" through "MEMORY = 8" items displayed on the AUDIO menu and the MEMORY menu show that settings are saved in memories 1 through 8.

When changing settings, you recall the memory number (1 through 8) containing the settings you want to change (p. 13).

* For SETUP menu settings, only a single set is saved in the unit.

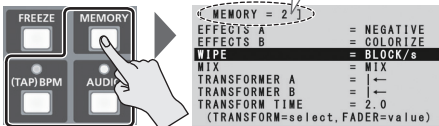

* The button lights up during menu display.

SETUP Menu

1. Press and hold the [(TAP) BPM] button (for 2 seconds or longer) to display the SETUP menu.
2. Press the [(TAP) BPM] button to quit the menu.

MEMORY Menu

1. Press the [MEMORY] button to display the MEMORY menu.
 - * This activates the memory function (p. 13), and the [A-1] through [A-4] and [B-1] through [B-4] buttons function as memory selection buttons 1 through 8.
2. Press the [A-1] through [A-4] or [B-1] through [B-4] button for the memory number containing the setting you want to change. The currently selected button lights up in blue.
 - * Selecting a memory number also recalls the saved settings.
3. Press the [MEMORY] button to quit the menu.

AUDIO Menu

1. Press the [AUDIO] button to display the AUDIO menu.
2. Press the [AUDIO] button to quit the menu.

Changing Setting Values

1. Use the [▲] and [▼] buttons to move the cursor and select a menu item.

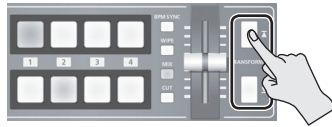

- Pressing and holding the [▲] or [▼] button makes the cursor move rapidly.
- While the AUDIO menu is displayed, you can also select menu items by pressing the following buttons.

Button	Menu item
[A-1]	HDMI INPUT 1 LEVEL
:	:
[A-4]	HDMI INPUT 4 LEVEL
[B-1]	AUDIO IN LEVEL
[B-2]	MIC LEVEL
[B-3]	MASTER OUT LEVEL
[B-4]	AUDIO FOLLOW

2. Use the A/B fader to change the setting value.

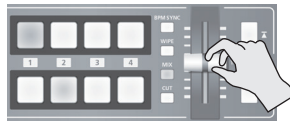

- * For the following SETUP menu items, you apply the setting by pressing the [▲] button. If 10 seconds elapse without applying the setting, the setting returns to its original value, with no change applied.
 - OUTPUT COLOR SPACE
 - OUTPUT DVI-D/HDMI
 - PREVIEW COLOR SPACE
 - PREVIEW DVI-D/HDMI
 - FRAME RATE

MEMO

- The values of menu settings are saved in the unit when you exit the menu. After changing settings, if you turn off the power without first quitting the menu, the changed setting values are not saved.
- For detailed information about menu items, refer to "Menu List" (p. 31).

Saving/Recalling Settings (Memory)

You can take the current settings, including video and audio settings and the state of the operation panel, and save them as a single set in the V-1HD's internal memory, for later recall and use when needed. The V-1HD is provided with eight memories.

Settings Saved in Memory

What you can save in memory are ① the MEMORY menu and AUDIO menu settings and ② the state of the operation panel.

Each uses a different method for saving its values in memory.

① MEMORY Menu/AUDIO Menu Settings

<Procedure for Saving>

Values are saved in memory when you quit each menu (p. 12).

② State of the Operation Panel

State of the [OUTPUT FADE] knob

State of the [EFFECTS A] and [EFFECTS B] knobs

On/off status of the EFFECTS A and EFFECTS B [ON] buttons

[A-1] through [A-4] button selection

[B-1] through [B-4] button selection

On/off status of the [BPM SYNC] button

[MIX], [WIPE] and [CUT] button selection

State of the A/B fader

<Procedure for Saving>

Turn on the memory function (lighted) and save the state of the operation panel in memory.

For more information on how to do this, refer to "Saving the State of the Operation Panel" on this page.

MEMO

- SETUP menu items are not saved in memory. Only a single set is saved in the unit.
- You can recall settings at a specified memory number at startup. Press and hold the [(TAP) BPM] button → use "POWER ON LOAD" at the SETUP menu to specify the memory number you want to recall.

NOTE

To update the state of the operation panel when recalling a memory

By default, the state of the operation panel is not updated when you recall a memory.

To update the state of the operation panel, press and hold the [(TAP) BPM] button → at the SETUP menu, set "MEMORY PANEL LOAD" to "ON."

Saving the State of the Operation Panel

This saves the state of the operation panel, including button and knob settings, in memory.

1. Press the [MEMORY] button to turn on the memory function (lighted).

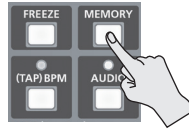

At this time the [A-1] through [A-4] and [B-1] through [B-4] buttons function as memory selection buttons 1 through 8.

The currently selected button lights up in blue.

2. Press and hold the [A-1] through [A-4] or [B-1] through [B-4] button for the memory number where you want to save the settings.

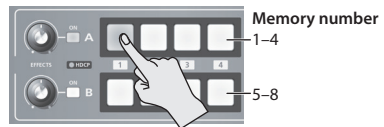

The [A-1] through [A-4] and [B-1] through [B-4] buttons all briefly light up in blue, and the current settings are saved.

3. To turn off the memory function, press the [MEMORY] button again.

Recalling a Memory

1. Press the [MEMORY] button to turn on the memory function (lighted).
2. Press the [A-1] through [A-4] or [B-1] through [B-4] button for the memory number you want to recall.
The settings are recalled. The currently selected button lights up in blue.
3. To turn off the memory function, press the [MEMORY] button again.

Video Input/Output Settings

Setting the Video Input/Output Format

You set the input/output format to match the incoming video signal.

- * Before setting the input/output format, first be sure to turn off the power to the V-1HD.

1. Slide the [FORMAT] switch on the rear panel to set the input/output format.

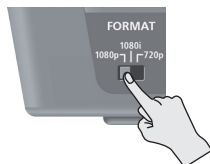

[FORMAT] switch	Inputtable formats	Output format
1080p	1080p, 1080i	1080p
1080i	1080p, 1080i	1080i
720p	720p	720p

MEMO

- The V-1HD's internal processing is progressive. Interlaced input video is automatically converted to a progressive signal. The picture might appear jagged at this time, or the picture in a PinP inset screen or preview four-way split screen might waver. This is due to progressive conversion, and is not a malfunction.
- The methods for converting an interlaced signal to a progressive signal are of two types: "BOB" and "WEAVE."

BOB	This interpolates the top field and bottom field, and unites them in a single frame. This is optimal for video that contains much movement.
WEAVE	This joins the top field and bottom field in a single frame. This is optimal for video that contains little movement.

To set the conversion method, press and hold the [(TAP) BPM] button → use "DEINTERLACE MODE" at the SETUP menu.

About Frame Rates

Frame rates that can be input are "59.94" and "50." Inputting video at a frame rate other than these might result in no output or dropped frames.

To change the frame rate, press and hold the [(TAP) BPM] button → select "FRAME RATE" at the SETUP menu → select "59.94" or "50" → press the [▲] button.

Adjusting Output Video

You can adjust the main output video or preview output video to match the equipment receiving output from the V-1HD.

MEMO

- You can output a color bar, useful for adjusting the image quality of a display. Press and hold the [(TAP) BPM] button → set "COLOR BAR OUTPUT" at the SETUP menu to "ON."

1. Press and hold the [(TAP) BPM] button (for 2 seconds or longer) to display the SETUP menu.
2. Use the [▲] and [▼] buttons to select an item.

[SETUP]	Page 1
BPM	= 120
BPM SYNC	= x1
HDCCP	= OFF
OUTPUT CONTRAST	= 0
OUTPUT SATURATION	= 0
OUTPUT BRIGHTNESS	= 0
OUTPUT COLOR SPACE	= AUTO
OUTPUT DVI-D/HDMI	= AUTO

You use the following items to adjust the main output video.

Menu item	Explanation
OUTPUT CONTRAST	This adjusts the contrast.
OUTPUT SATURATION	This adjusts the saturation.
OUTPUT BRIGHTNESS	This adjusts the brightness.
OUTPUT COLOR SPACE	This sets the color space.
OUTPUT DVI-D/HDMI	This sets the output mode.

You use the following items to adjust the preview output video.

Menu item	Explanation
PREVIEW CONTRAST	This adjusts the contrast.
PREVIEW SATURATION	This adjusts the saturation.
PREVIEW BRIGHTNESS	This adjusts the brightness.
PREVIEW COLOR SPACE	This sets the color space.
PREVIEW DVI-D/HDMI	This sets the output mode.

3. Use the A/B fader to adjust the main output video or preview output video.

- * The settings for the following menu items are applied by pressing the [▲] button. If 10 seconds elapse without applying the setting, the setting returns to its original value, with no change applied.

- OUTPUT COLOR SPACE
- OUTPUT DVI-D/HDMI
- PREVIEW COLOR SPACE
- PREVIEW DVI-D/HDMI

4. Press the [(TAP) BPM] button to quit the menu.

Switching the View Mode of Preview Output

Three types of view modes are available for the V-1HD's preview output.

1. Press and hold the [(TAP) BPM] button (for 2 seconds or longer) to display the SETUP menu.
2. Use the [▲] and [▼] buttons to select "PREVIEW OUT."

[SETUP]	Page 2
PREVIEW CONTRAST	= 0
PREVIEW SATURATION	= 0
PREVIEW BRIGHTNESS	= 0
PREVIEW COLOR SPACE	= AUTO
PREVIEW DVI-D/HDMI	= AUTO
PREVIEW OUT	= MULTI-VIEW
PinP BORDER	= 3
PinP BORDER COLOR	= WHITE

3. Use the A/B fader to set the view mode.

Value	Explanation
MULTI-VIEW	This displays the incoming video on channels 1 through 4 as a four-way split screen. The input video is arranged as shown below. 
OUTPUT	This displays the video currently being output.
PREVIEW	This displays the video to be output next.

The video is displayed with a colored border that is interlinked with the selected [A-1] through [A-4] or [B-1] through [B-4] button.
 Red border: Video currently being output
 Green border: Video to be output next

4. Press the [(TAP) BPM] button to quit the menu.

Inputting Copyright-protected (HDCP) Video

To input copyright-protected (HDCP) video from a Blu-ray Disc player or the like, you make the setting for enabling HDCP input.

* The V-1HD must be connected to an HDCP compatible display for HDCP protected video to be connected.

What's HDCP?

HDCP is copyright-protection technology that prevents unlawful copying of content by encoding the path when sending digital signals from a video playback device to a display monitor or other display equipment.

1. Press and hold the [(TAP) BPM] button (for 2 seconds or longer) to display the SETUP menu.
2. Use the [▲] and [▼] buttons to select "HDCP."

[SETUP]	Page 1
BPM	= 120
BPM SYNC	= x1
HDCP	= OFF
OUTPUT CONTRAST	= 0
OUTPUT SATURATION	= 0
OUTPUT BRIGHTNESS	= 0
OUTPUT COLOR SPACE	= AUTO
OUTPUT DVI-D/HDMI	= AUTO

3. Use the A/B fader to set this to "ON."

Value	Explanation
ON	Copyright-protected (HDCP) video can be input. HDCP is also added to the video that is output.
OFF	Copyright-protected (HDCP) video cannot be input.

4. Press the [(TAP) BPM] button to quit the menu.

Operation of the HDCP indicator

The HDCP indicator on the top panel operates as follows, regardless of input.



Indicator	"HDCP" setting	Connection status
Lighted	ON	An HDCP-compatible device is connected to the OUTPUT or PREVIEW connector.
Flashing	ON	No HDCP-compatible device is connected to the OUTPUT or PREVIEW connector. Alternatively, a device that does not support HDCP is connected.
Dark	OFF	—

Video Operations

Switching the Video

You can switch the video input to bus A and to bus B of the video mixer.

Switching Using the A/B Fader

You operate the A/B fader to switch between two video feeds. The video on the bus toward which the A/B fader is flipped is output (A/B mode).

1. Use the [A-1] through [A-4] and [B-1] through [B-4] buttons to select the video to input on bus A and bus B.



Lighted in red: Video currently being output
 Lighted in green: Video to be output next
 Lighted in white: Channel with video input

2. Press the [WIPE], [MIX], or [CUT] button to select a transition effect.

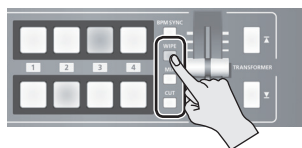

The selected button lights up.

Button	Explanation
[WIPE]	The original video is broken into by the next video.
[MIX]	As the original picture gradually disappears, the next video is overlaid and progressively grows more visible.
[CUT]	The picture switches instantly.

MEMO

- You can change the transition pattern used for a wipe or mix transition. For details, refer to “Using a Different Transition Pattern” (p. 19).

3. Move the A/B fader to the bus A position or the bus B position.

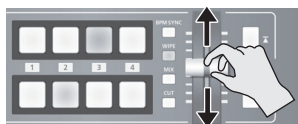

The output video is switched

MEMO

- You can change the color in which the [A-1] through [A-4] and [B-1] through [B-4] buttons light up. Press and hold the [(TAP) BPM] button → at the SETUP menu, use “PGM LED” (buttons for current video output) or “PST LED” (buttons for next video output) to make the setting.
- Directly selecting the video channel at the bus position of the video currently being output switches the video with a cut, regardless of any selection of a transition effect.

About the Operation Mode for Video Transitions

Two operation modes are available for video transitions made using the A/B fader: the “A/B mode” and the “PGM/PST mode.”

To set the operation mode, press and hold the [(TAP) BPM] button → use “A/B MODE” at the SETUP menu.

A/B Mode

The video on the bus toward which the A/B fader is flipped is output.

PGM/PST Mode

	PGM Lighted in red: Video currently being output Lighted in green: Video to be output next
--	--

The video at the PGM (bus A) position is always output, and for PST (the bus B position), these select the video to be output next.

Operating the A/B fader causes the selected video at the PST (bus B) position to be output from the PGM (bus A) position.

* Bus assignments made using EFFECTS [ON] buttons or TRANSFORMER buttons (bus A or bus B) do not change.

Switching Using the TRANSFORMER Buttons

You can switch video using the TRANSFORMER buttons, without using the A/B fader. This section describes the operations, using the factory-default memory number 1 settings as an example.

- Use the [A-1] through [A-4] and [B-1] through [B-4] buttons to select the video to input on bus A and bus B.



Lighted in red: Video currently being output
 Lighted in green: Video to be output next
 Lighted in white: Channel with video input

- Press a TRANSFORMER button to switch the video on bus A and bus B.



Pressing the TRANSFORMER [▲] button switches to the video on bus A.



Pressing the TRANSFORMER [▼] button switches to the video on bus B.

* By factory default, the operation of the TRANSFORMER buttons is set as follows in memory number 1.

MEMORY menu item	Value
TRANSFORMER A	←
TRANSFORMER B	←

MEMO

- You can change the operations performed when TRANSFORMER buttons are pressed. For details, refer to “Changing the Operation of the TRANSFORMER Buttons” on this page.
- When you use the TRANSFORMER buttons to switch video, the actual output might come to differ from the position of the A/B fader. Operating the A/B fader while in this state yields no change in output until the position of the A/B fader matches the actual output.
- You can make the TRANSFORMER buttons dark. Press and hold the [(TAP) BPM] button → set “TRANSFORMER LED” on the SETUP menu to “OFF.”

Changing the Operation of the TRANSFORMER Buttons

- Press the [MEMORY] button to display the MEMORY menu.
- Use the [▲] and [▼] buttons to select “TRANSFORMER A” or “TRANSFORMER B”

```
[ MEMORY = 2 ]
EFFECTS A      = NEGATIVE
EFFECTS B      = COLORIZE
WIPE           = BLOCK/s
MIX            = MIX
TRANSFORMER A  = |←
TRANSFORMER B  = |←
TRANSFORM TIME = 2.0
(TRANSFORM=select, FADER=value)
```

- Use the A/B fader to specify the operation of the TRANSFORMER buttons.

Value	Explanation
NONE	Button operation is disabled. (*1)
TRANSFORM	The video is switched to the video for the bus position of the pressed button until you release the button.
←	Pressing a button switches the video to the video for the bus position of the pressed button. (*2)
←→	Each press of a button switches the bus A and bus B video. (*2)
WHITE	A white picture is output until the button is released.
BLACK	A black picture is output until the button is released.
BPM SYNC	The [BPM SYNC] button is selected until the pressed button is released.
WIPE	The [WIPE] button is selected until the pressed button is released.
MIX	The [MIX] button is selected until the pressed button is released.
CUT	The [CUT] button is selected until the pressed button is released.
EFFECTS	The effect for the bus position of the pressed button is turned on until you release the button.

(*1) The TRANSFORMER buttons are dark when this is set to “NONE.”

(*2) When a mix or wipe has been selected as the transition effect, the value set for “TRANSFORM TIME” at the MEMORY menu is used for the video transition time.

- Press the [MEMORY] button to quit the menu.

Switching in Time with Music (BPM Sync)

You can switch video in time with a musical beat. The video is switched automatically, with no operation of the A/B fader or the TRANSFORMER buttons.

Setting BPM Using a Numerical Value

Setting BPM using a numerical value makes the video switch beat by beat.

1. Use the [A-1] through [A-4] and [B-1] through [B-4] buttons to select the video to input on bus A and bus B.



2. Press and hold the [(TAP) BPM] button (for 2 seconds or longer) to display the SETUP menu.
3. Use the [▲] and [▼] buttons to select "BPM."

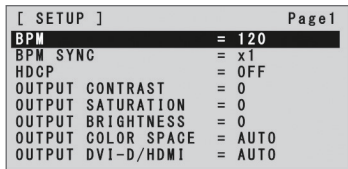

4. Use the A/B fader to set the BPM. The setting range for BPM is from 20 to 250.
5. Press the [BPM SYNC] button to turn on BPM sync (lighted).



The [BPM SYNC] button lights up, and the video is automatically switched in time with the value set for BPM.

6. To turn off BPM sync, press the [BPM SYNC] button a second time.

MEMO

- You can also change the speed at which the video is switched to a speed that is a multiple of the value set for BPM. the [(TAP) BPM] button → use "BPM SYNC" at the SETUP menu to make the setting.
- When you use BPM sync to switch video, the actual output might come to differ from the position of the A/B fader. Operating the A/B fader while in this state yields no change in output until the position of the A/B fader matches the actual output.

Setting BPM by the Timing of Pressing the [(TAP) BPM] Button

You can set the BPM according to the timing with which you press the [(TAP) BPM] button, and make the video switch beat by beat.

1. Use the [A-1] through [A-4] and [B-1] through [B-4] buttons to select the video to input on bus A and bus B.



2. Press the [BPM SYNC] button to turn on BPM sync (lighted).



The video is automatically switched in time with the value currently set for BPM.

3. Press the [(TAP) BPM] button repeatedly to set the BPM.

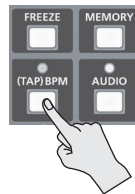

Repeatedly press the [(TAP) BPM] button in time with a musical beat. The BPM changes continuously according to the timing with which you press the [(TAP) BPM] button. The video is automatically switched in time with the changed BPM.

4. To turn off BPM sync, press the [BPM SYNC] button a second time.

Switching Automatically (Auto Scan)

The video on channels 1 through 4 is switched automatically in sequence.

MEMO

- Any channels carrying no video input are skipped.
- Switching the video manually is not possible while an automatic switch is in progress.

1. Press and hold the [(TAP) BPM] button (for 2 seconds or longer) to display the SETUP menu.
2. Use the [▲] and [▼] buttons to select "AUTO SCAN."

[SETUP]		Page 3
AUTO SCAN	= OFF	
AUTO SCAN TIME	= 5sec	
AUTO SCAN TRANS TIME	= 0.5sec	
A/B MODE	= A/B	
FREEZE MODE	= ALL	
NO SIGNAL BACK	= BLACK	
UNFIT SIGNAL BACK	= BLACK	
DEINTERLACE MODE	= WEAVE	

3. Use the A/B fader to set this to "ON."

Value	Explanation
ON	Video automatic switching is turned on. The video on channels 1 through 4 is switched automatically.
OFF	The video automatic switching feature is turned off.

- You can use the following SETUP menu items to set the transition interval for video display and the time applies to the video transition.

Menu item	Explanation
AUTO SCAN TIME	This sets the display interval for video within a range of 1 to 120 seconds.
AUTO SCAN TRANS TIME	This sets the time the video transition takes, within a range of 0.0 to 4.0 seconds. * These are effective when a mix or wipe is selected as the transition effect.

- * If the time the video transition takes is longer than the video display interval, the next transition starts before the current transition is complete.

4. Press the [(TAP) BPM] button to quit the menu.

Using a Different Transition Pattern

A variety of transition patterns are available for mix and wipe transition effects.

To use a different pattern, change the transition pattern assigned to the [MIX] or [WIPE] button.

1. Press the [MEMORY] button to display the MEMORY menu.
2. Use the [▲] and [▼] buttons to select "WIPE" or "MIX."

[MEMORY = 2]	
EFFECTS A	= NEGATIVE
EFFECTS B	= COLORIZE
WIPE	= BLOCK/s
MIX	= MIX
TRANSFORMER A	= ←
TRANSFORMER B	= ←
TRANSFORM TIME	= 2.0
(TRANSFORM=select, FADER=value)	

3. Use the A/B fader to change the transition pattern.

- * For a list of transition-pattern types, refer to "Transition Effects List" (p. 35).

4. Press the [MEMORY] button to quit the menu.

MEMO

- When the [WIPE] button is selected, you can change the transition pattern with each press of the [WIPE] button. Press and hold the [(TAP) BPM] button → set "WIPE TYPE CHANGE" at the SETUP menu to "ON."
The procedure is similar for the [MIX] button. Set "MIX TYPE CHANGE" at the SETUP menu to "ON."

Applying a Fade to the Main Output Video (Output Fade)

You can apply a fade to the V-1HD's main output video. This lets you make the main output video fade to a black (or white) picture at times when you want to suppress video output, such as during intervals in a presentation, event or band performance.

Applying a Fade-out

1. Turn the [OUTPUT FADE] knob all the way clockwise or counterclockwise.



Turning the [OUTPUT FADE] knob clockwise performs a fade-out to white, and turning the knob counterclockwise performs a fade-out to black.

Applying a fade makes the indicators to the left or right of the knob flash.

Applying a Fade-in

1. Return the [OUTPUT FADE] knob to its center position.



The indicator stops flashing and lights up steadily, and output starts.

Freezing Input Video (Freeze)

This temporarily pauses the incoming video. You can apply transition effects and other effects during a video freeze.

Setting the Freeze Mode

Two operation modes are available for freezes: the "ALL mode" and the "SELECT mode."

By factory default, this is set to "ALL" (freeze all incoming video).

If you want to select the input video to freeze, press and hold the [(TAP) BPM] button → set "FREEZE MODE" at the SETUP menu to "SELECT"

Freezing Input Video



When the Freeze Mode Is Set to "ALL"

1. Press the [FREEZE] button to turn on freeze (lighted). All video that is input freezes.
2. To turn off freeze, press the [FREEZE] button a second time.

When the Freeze Mode Is Set to "SELECT"

1. Press the [FREEZE] button to turn on freeze (lighted). The [A-1] through [A-4] buttons all flash in red.
2. Press one of the [A-1] through [A-4] buttons to select the incoming video you want to freeze.

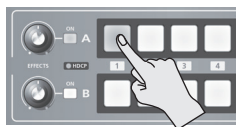

The selected input video freezes.

3. To turn off freeze, press the [FREEZE] button a second time.

Video Effect Operations

You can apply effects to the main output video. The V-1HD has nine types of built-in filter effects and ten types of built-in compositing effects.

Using Filter Effects

These apply effects such as changes in video color tone and appearance to the entire video. You can set filter effects separately for the video on bus A and on bus B.

Selecting a Filter Effect

1. Press the [MEMORY] button to display the MEMORY menu.
2. Use the [▲] and [▼] buttons to select "EFFECTS A" or "EFFECTS B."

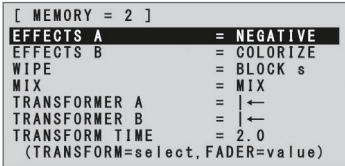

3. Use the A/B fader to select the filter effect to assign to the EFFECTS A or B [ON] button.

Value	Explanation
NEGATIVE	This inverts the brightness and colors.
EMBOSS	This adds a bas-relief effect to the video.
COLORIZE	This adds color to the video.
COLORPASS	This produces monochrome video with a specific color remaining.
POSTERIZE	This changes the gradations in brightness.
SILHOUETTE	This separates the video into light and dark areas, and makes the dark areas black and adds a different color to the light areas.
MONOCOLOR	This produces monochrome video.
FINDEDGE	This extracts contours.
FLIP	This flips the video.

4. Press the [MEMORY] button to quit the menu.

MEMO

- You can change the effect type by holding down the EFFECTS A [ON] button and turning the [EFFECTS A] knob. You can change EFFECTS B as well in the same way. Press and hold the [(TAP) BPM] button → set "EFFECTS TYPE CHANGE" at the SETUP menu to "ON."

Applying Filter Effects

1. Output the video to which you want to apply an effect.
2. Press the EFFECTS A or B [ON] button to turn on the effect (lighted).



You can turn on effects separately for the output video signals on bus A and bus B.

3. Turn the [EFFECTS A] or [EFFECTS B] knob to adjust the degree of effect applied.



4. To turn off an effect, press the EFFECTS A or B [ON] button a second time.

Using Compositing Effects

These composite the bus A video and the bus B video.

NOTE

- When compositing effects are turned on for either bus A or bus B, no effects can be applied to the other bus.

Selecting a Compositing Effect

- Press the [MEMORY] button to display the MEMORY menu.
- Use the [▲] and [▼] buttons to select "EFFECTS A" or "EFFECTS B."
- Use the A/B fader to select the compositing effect to assign to the EFFECTS A or B [ON] button.

Value	Explanation
WHT-L. KEY	This makes white areas of the video transparent and composites it onto a background video.
BLK-L. KEY	This makes black areas of the video transparent and composites it onto a background video.
GRN-C. KEY	This extracts the green portions of the video and composites it onto a background video.
BLU-C. KEY	This extracts the blue portions of the video and composites it onto a background video.
PinP 1/4	This composites video in an inset screen onto a background video. The horizontal size of the inset screen is 1/4 the width of the background video.
PinP 1/2	This composites video in an inset screen onto a background video. The horizontal size of the inset screen is 1/2 the width of the background video.
SPLIT-VS	This composites the video stretched vertically.
SPLIT-VC	This composites the video with its center section vertically cropped.
SPLIT-HS	This composites the video stretched horizontally.
SPLIT-HC	This composites the video with its center section horizontally cropped.

- Press the [MEMORY] button to quit the menu.

MEMO

- You can change the effect type by holding down the EFFECTS A [ON] button and turning the [EFFECTS A] knob. You can EFFECTS B as well in the same way. Press and hold the [(TAP) BPM] button → set "EFFECT TYPE CHANGE" at the SETUP menu to "ON."

Compositing Using Luminance Key

This composites video with white or black areas made transparent onto a background video. Using luminance keying lets you superimpose logos or text onto a background picture.



- Follow the procedure in "Selecting a Compositing Effect" on this page to select "WHT-L.KEY" or "BLK-L.KEY."
- Press the EFFECTS A (or B) [ON] button to turn on the effect (lighted).



- Press the [A-1] through [A-4] and [B-1] through [B-4] buttons to separately select the background and the picture you want to display in the foreground. The video on the bus at the position where you turned on the effect in step 2 is displayed in the foreground.
- Turn the [EFFECTS A] and [EFFECTS B] knobs to adjust the amount of effect applied.



[EFFECTS A] knob

This adjusts the amount of keying for the foreground video.

[EFFECTS B] knob

This adjusts the degree of edge blur for the foreground video.

- To turn off an effect, press the EFFECTS A (or B) [ON] button a second time.

Compositing Using Chroma Key

This composites video shot against a blue or green background against a different background video.



Blue or Green

NOTE

- Chroma-key composition sometimes leaves color or small artifacts at the edges of the extracted video, but this is not a malfunction.

1. Follow the procedure in “Selecting a Compositing Effect” (p. 22) to select “GRN-C. KEY” or “BLU-C.KEY.”
2. Press the EFFECTS A (or B) [ON] button to turn on the effect (lighted).



3. Press the [A-1] through [A-4] and [B-1] through [B-4] buttons to separately select the background and the picture you want to display in the foreground.

The video on the bus at the position where you turned on the effect in step 2 is displayed in the foreground.

4. Turn the [EFFECTS A] and [EFFECTS B] knobs to adjust the amount of effect applied.



[EFFECTS A] knob
This adjusts the amount of keying for the foreground video.

[EFFECTS B] knob
This adjusts the degree of edge blur for the foreground video.

5. To turn off an effect, press the EFFECTS A (or B) [ON] button a second time.

Compositing Using Picture-in-Picture

This composites video in an inset screen onto a different background video.

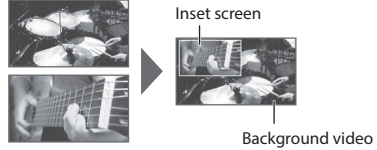

Inset screen

Background video

1. Follow the procedure in “Selecting a Compositing Effect” (p. 22) to select “PinP 1/4” or “PinP 1/2.”
2. Press the EFFECTS A (or B) [ON] button to turn on the effect (lighted).



3. Use the [A-1] through [A-4] and [B-1] through [B-4] buttons to separately select the video you want to use as the background and as the inset screen.

The video on the bus at the position where you turned on the effect in step 2 becomes the inset screen.

4. Move the A/B fader to the bus A position.

The inset screen is composited onto the background video and the result is output.

- * When the A/B fader has been moved all the way to the bus B position, no inset screen is displayed.

5. Turn the [EFFECTS A] and [EFFECTS B] knobs to adjust the display position of the inset screen.



[EFFECTS A] knob
This adjusts the inset screen's display position horizontally.

[EFFECTS B] knob
This adjusts the inset screen's display position vertically.

6. To turn off an effect, press the EFFECTS A (or B) [ON] button a second time.

MEMO

- You can change the width and color of the border added to the inset screen.

Press and hold the [(TAP) BPM] button → at the SETUP menu, make the settings for “PinP BORDER” and “PinP BORDER COLOR.”

Compositing Using Split

This composites two video streams in a split screen. The bus A video is displayed above or on the left, and the bus B video is displayed below or on the right.

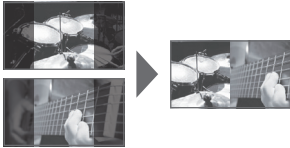

MEMO

- While compositing of the video is in progress, the video switches with cuts regardless of the selected transition effect.

1. Follow the procedure in “Selecting a Compositing Effect” (p. 22) to select “SPLIT-VS,” “SPLIT-VC,” “SPLIT-HS,” or “SPLIT-HC.”
2. Press the EFFECTS A (or B) [ON] button to turn on the effect (lighted).



3. Press one of the [A-1] through [A-4] buttons to select the video you want to display above or on the left.
4. Press one of the [B-1] through [B-4] buttons to select the video you want to display below or on the right.
5. Turn the [EFFECTS A] and [EFFECTS B] knobs to adjust the center position.

* You can adjust this when you selected “SPLIT-HC” or “SPLIT-VC” in step 1.



[EFFECTS A] knob
This adjusts the center position horizontally.

[EFFECTS B] knob
This adjusts the center position vertically.

6. To turn off an effect, press the EFFECTS A (or B) [ON] button a second time.

Audio Operations

Adjusting the Volume Level

This adjusts the volume level of input audio and output audio.

MEMO

- You can output a test tone, which is useful for adjusting the volume level. Press and hold the [(TAP) BPM] button → set “TEST TONE OUTPUT” at the SETUP menu to “ON.”

- Press the [AUDIO] button to display the AUDIO menu.
- Use the [▲] and [▼] buttons to select the input audio whose volume level you want to adjust.

[AUDIO] MEMORY = 2 Page 1	
HDMI IN 1 LEVEL	= 100
HDMI IN 2 LEVEL	= 100
HDMI IN 3 LEVEL	= 100
HDMI IN 4 LEVEL	= 100
AUDIO IN LEVEL	= 100
MIC LEVEL	= 100
MASTER OUT LEVEL	= 100
AUDIO FOLLOW	= OFF

You use the following items to adjust the volume level of input audio.

Menu item	Explanation
HDMI IN 1-4 LEVEL	Input audio from respective HDMI sources
AUDIO IN LEVEL	Input audio from AUDIO IN
MIC LEVEL	Input audio from MIC

- Use the A/B fader to adjust the volume level for the respective input audio.



Raise the volume level of audio you want to make more prominent, such as, for example, a - microphone, and lower the volume level for other audio.

When no audio is input, and for audio that is unused, set the volume level to “0” (zero).

MEMO

- Setting “MASTER OUT LEVEL” to “0” (zero) results in no audio output from the output connectors.

- Use the [▲] and [▼] buttons to select “MASTER OUT LEVEL.”
- Use the A/B fader to adjust the volume level of output audio.
- Press the [AUDIO] button to quit the menu.

MEMO

- When the [AUDIO] button is illuminated, the [A-1] through [A-4] and [B-1] through [B-3] buttons function as shortcuts for AUDIO menu selection. You can select audio whose volume level you want to adjust by pressing a shortcut button.



Button	AUDIO menu
[A-1]	HDMI IN 1 LEVEL
:	:
[A-4]	HDMI IN 4 LEVEL
[B-1]	AUDIO IN LEVEL
[B-2]	MIC LEVEL
[B-3]	MASTER OUT LEVEL

- To adjust MIC input sensitivity, you use the [MIC] knob on the side panel.
- The AUDIO indicator above the [AUDIO] knob lights up as follows according to audio input and output.

Indicator	Status
Lighted in green	This lights up in green when audio input is detected.
Lighted in red	This lights up in red when the volume level exceeds the maximum input/output level. Audio output from the V-1HD might be distorted in such cases.

- * By factory default, the display of the AUDIO indicator is set to “MASTER OUT” (output audio signal level). If you want to use the AUDIO indicator to monitor other audio signal, press and hold the [(TAP) BPM] button → make the setting using “AUDIO LED” at the SETUP menu.

Applying Effects to Audio

You can apply effects to audio that is input and output to adjust its sound quality.

Applying Effects to Input Audio

This applies effects and adjusts sound quality for audio input via AUDIO IN, MIC, and HDMI IN.

The following table shows the effects you can use with the different input audio streams.

Input audio	Effects				
	EQ	DELAY	GATE	COMP	HPF
AUDIO IN	✓	✓	—	—	—
MIC	✓	✓	✓	✓	✓
HDMI IN	✓	✓	—	—	—

1. Press the [AUDIO] button to display the AUDIO menu.
2. Use the [▲] and [▼] buttons to select the effect menu item you want to use.

[AUDIO] MEMORY = 2	Page 8
MIC COMP	= OFF
MIC COMP-THRESHOLD	= -16dB
MIC COMP-RATIO	= 1NF : 1
MIC COMP-ATTACK	= 50ms
MIC COMP-RELEASE	= 500ms
MIC GATE	= OFF
MIC GATE-THRESHOLD	= -48dB
MIC GATE-RELEASE	= 500ms

* For more information about effects, refer to the following section.

3. Use the A/B fader to adjust the setting value.
4. Press the [AUDIO] button to quit the menu.

Equalizer (EQ)

This adjusts the sound quality for each frequency band.

Menu item	Explanation
HDMI IN 1	EQ Hi This boosts or attenuates the high band.
:	EQ Hi This adjusts the center frequency when
HDMI IN 4	FREQ changing the sound quality in the high
AUDIO IN	band.
MIC	EQ Mid This boosts or attenuates the middle band.
	EQ Mid This adjusts the center frequency when
	FREQ changing the sound quality in the
	middle band.
	EQ Mid This adjusts the width of the frequency
	Q band when boosting or attenuating the
	middle band.
	EQ Lo This boosts or attenuates the low band.
	EQ Lo This adjusts the center frequency when
	FREQ changing the sound quality in the low
	band.

Delay (DELAY)

This outputs audio with a delay.

Delaying audio output lets you align the output timing of video and audio.

Menu item	Explanation
HDMI IN 1	DELAY This adjusts the delay time for audio.
:	
HDMI IN 4	
AUDIO IN	
MIC	

Compressor (COMP)

This compresses audio that exceeds a specified level.

Menu item	Explanation
MIC COMP	This sets the compressor on or off.
MIC COMP-THRESHOLD	This sets the level used as the threshold when compressing audio. Compression is applied to audio that exceeds the level set here.
MIC COMP-RATIO	This specifies the degree of compression applied to the audio. The state in which no compression is applied is defined as "1."
MIC COMP-ATTACK	This sets the time until compression starts when audio exceeding the threshold is input.
MIC COMP-RELEASE	This adjusts the length of time until compression ends after audio falls below the threshold.

Gate (GATE)

This mutes audio that is below a specified level.

Menu item	Explanation
MIC GATE	This sets gate on or off.
MIC GATE-THRESHOLD	This sets the level used as the threshold for removing audio. Audio below the level set here is removed.
MIC GATE-RELEASE	This adjusts the length of time until the audio is fully attenuated after audio falls below the threshold.

High-pass Filter (HPF)

This cuts off unneeded low-band audio. The cutoff frequency is 75 Hz.

Menu item	Explanation
MIC HPF	This sets the high-pass filter on or off.

Applying Effects to Output Audio

This applies effects and adjusts the sound quality for output audio.

1. Press the [AUDIO] button to display the AUDIO menu.
2. Use the [▲] and [▼] buttons to select the effect menu item you want to use.

[AUDIO] MEMORY = 2	Page 9
MIC HPF = OFF	
MAIN EQ Hi = 0dB	
MAIN EQ Hi FREQ = 8.00KHz	
MAIN EQ Mid = 0dB	
MAIN EQ Mid FREQ = 2.50KHz	
MAIN EQ Mid Q = 0.5	
MAIN EQ Lo = 0dB	
MAIN EQ Lo FREQ = 110Hz	

* For more information about effects, refer to the following section.

3. Use the A/B fader to adjust the setting value.
4. Press the [AUDIO] button to quit the menu.

Equalizer (EQ)

This adjusts the sound quality for each frequency band.

Menu item	Explanation
MAIN EQ Hi	This boosts or attenuates the high band.
MAIN EQ Hi FREQ	This adjusts the center frequency when changing the sound quality in the high band.
MAIN EQ Mid	This boosts or attenuates the middle band.
MAIN EQ Mid FREQ	This adjusts the center frequency when changing the sound quality in the middle band.
MAIN EQ Mid Q	This adjusts the width of the frequency band when boosting or attenuating the middle band.
MAIN EQ Lo	This boosts or attenuates the low band.
MAIN EQ Lo FREQ	This adjusts the center frequency when changing the sound quality in the low band.

Mastering (MASTERING)

This adjusts the acoustic characteristics and tone quality.

Menu item	Explanation
MASTERING	This switches mastering on and off.
MASTERING NS	This adjusts the degree of application of the noise suppressor.
MASTERING ENHANCER	This adjusts the degree of application of the enhancer.
MASTERING Hi	This suppresses high-frequency distortion and adjusts the sound to have sustained tones.
MASTERING Mid	This suppresses midrange distortion and adjusts the sound to have distinct tones.
MASTERING Lo	This suppresses low-frequency distortion and adjusts the sound to have stable tones.

Reverb (REVERB)

This adds lingering reverberations to the audio.

You can apply reverb to audio input via AUDIO IN, MIC, and HDMI IN.

Menu item	Explanation
REVERB LEVEL	This adjusts the return level from reverb of the audio. A setting of "0" results in no reverb applied.
REVERB TIME	This adjusts the length of the reverb.
REVERB TYPE	This specifies the type of reverb. ROOM: Produces the natural reverberations of a highly resonant room. HALL: Produces reverberations like that of a performance in a concert hall or other such space.

1. Press the [AUDIO] button to display the AUDIO menu.
2. Use the [▲] and [▼] buttons to select "REV SEND" for the input audio on which you want to apply reverb.

Menu item	Explanation
HDMI IN 1 : HDMI IN 4 AUDIO IN MIC	REV SEND This adjusts the amount of audio sent to reverb for each different input audio stream.

3. Use the A/B fader to adjust the amount of audio sent to reverb.
Repeat steps 2 and 3 as needed to individually adjust the amount of reverb applied.
4. Use the [▲] and [▼] buttons to select "REVERB LEVEL."
5. Use the A/B fader to adjust the amount of audio returned from reverb.
This adjusts the depth of overall reverb applied while maintaining the balance in the degree of reverb applied to the individual input audio streams.
6. Press the [AUDIO] button to quit the menu.

Interlinking Audio Output to Video Switching (Audio Follow)

You can associate audio with a video switch so that when the video is switched, only the HDMI audio of the output video is output, and other HDMI audio is automatically muted.

You can also use Audio Follow with audio input via AUDIO IN or MIC.

1. Follow the procedure in “Adjusting the Volume Level” (p. 25) to adjust the volume to the level you want to output.
2. Press the [AUDIO] button to display the AUDIO menu.
3. Use the [▲] and [▼] buttons to select “AUDIO FOLLOW.”

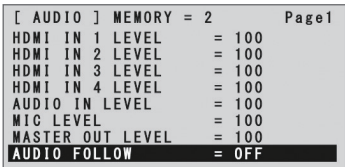

* When the [AUDIO] button is lighted, the [B-4] button functions as a shortcut for selecting “AUDIO FOLLOW.” You can also select “AUDIO FOLLOW” by pressing the [B-4] button.

4. Select the input audio to use with Audio Follow.

Value	Explanation
ON	This sets the Audio Follow feature on. When the video is switched, only the interlinked HDMI audio of the output video is output, and other HDMI audio is muted.
OFF	This sets the Audio Follow feature off.

5. Press the [AUDIO] button to quit the menu.

6. Switch the video.

When the video input channel is switched, only the interlinked HDMI audio of the output video is output.

* Other settings are required to use Audio Follow with audio input via AUDIO IN or MIC. For details, refer to “Adding Audio Follow Associations” on this page.

Adding Audio Follow Associations

You can use Audio Follow with audio input via AUDIO IN or MIC.

1. Press the [AUDIO] button to display the AUDIO menu.
2. Use the [▲] and [▼] buttons to select “A. FOLLOW AUDIO IN” or “A. FOLLOW MIC.”

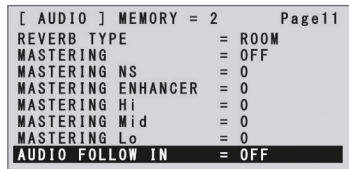

Select the input audio to use with Audio Follow.

Menu item	Explanation
A. FOLLOW AUDIO IN	Input audio from AUDIO IN
A. FOLLOW MIC	Input audio from MIC

3. Use the A/B fader to specify the video input channel to use with Audio Follow.

Value	Explanation
1-4	This sets the video input channel to interlink with input audio using Audio Follow.
OFF	This assigns no video input channel to Audio Follow. Audio is always output, regardless of whether the Audio Follow feature is on or off.

4. Press the [AUDIO] button to quit the menu.

When the Audio Follow feature is turned on, audio input via AUDIO IN or MIC is muted on video input channels other than the channel specified in step 3.

Other Features

Returning Settings to the Factory-default State (Factory Reset)

You can return the values of settings on the V-1HD to their factory defaults.

If operation that differs from what is described in the Owner's Manual occurs even when the steps described are followed correctly, try performing a factory reset.

NOTE

- Performing a factory reset causes all settings made and values saved in memory (p. 13) to be lost.

- Press and hold the [(TAP) BPM] button (for 2 seconds or longer) to display the SETUP menu.
- Use the [▲] and [▼] buttons to select "FACTORY RESET."

[SETUP]		Page 6
MIX TYPE CHANGE	=	0N
AUTO OFF	=	0N
FRAME RATE	=	59.94
FACTORY RESET	=	---
VERSION	=	1.00

- Move the A/B fader to the bus A position.
- Make sure the message "PRESS "UP"" is displayed, and press the [▲] button.
(If you want to cancel the operation, move the A/B fader to the bus B position or press the [▼] button.)
A factory reset is executed.
- Press the [(TAP) BPM] button to quit the menu.

Operating the V-1HD by Remote Control

You can use V-1HD RCS dedicated software to remotely control the following functions on the V-1HD from a computer or tablet connected via USB.

- V-1HD panel operations
- Selecting transition effects
- Audio mixer operation
- Memory save/load operations

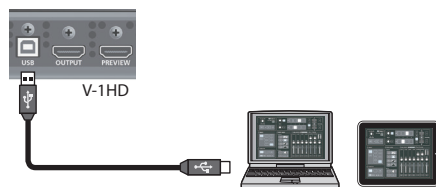

V-1HD RCS can be downloaded from the following Roland website.

For more information about operation methods, refer to the owner's manual included with V-1HD RCS.

<http://proav.roland.com>

About Remote Control Via MIDI

The V-1HD also supports remote control by equipment compatible with MIDI Visual Control.

For information on remote control via MIDI, download and refer to the "V-1HD Remote Control Guide" (PDF) from the Roland website mentioned above.

What's MIDI Visual Control?



MIDI Visual Control is an internationally-used recommended practice that was added to the MIDI specification so that visual expression could be linked with musical performance.

Video equipment that is compatible with MIDI Visual Control can be connected to electronic musical instruments via MIDI in order to control video equipment in tandem with a performance.

Appendices

Troubleshooting

If you suspect a malfunction, please check the following points. If this does not resolve the problem, contact a nearby Roland Service Center.

Problem	Items to check	Action	Page
Video-related problems			
No picture is input.	Are the [A-1] through [A-4] and [B-1] through [B-4] buttons flashing in white?	Video whose format differs from the [FORMAT] switch setting is input. Input video that is compatible with the specified format.	p. 14
	Is copyright-protected (HDCP) video being input?	When inputting copyright-protected (HDCP) video signals, go to the SETUP menu and set "HDCP" to "ON."	p. 15
Video from the computer is not displayed.	Is the format of the video output from the computer compatible with the V-1HD's input formats?	The supported input formats on the V-1HD are 1080p, 1080i, and 720p. VESA-standard resolutions are not supported.	p. 14
No picture is output.	Has the [OUTPUT FADE] knob been turned clockwise or counterclockwise?	When the [OUTPUT FADE] knob is turned clockwise or counterclockwise, fade is applied to the main output video. When outputting video, adjust the [OUTPUT FADE] knob to its center position.	p. 20
	Is the display connected correctly?	When outputting copyright-protected (HDCP) video, connect an HDCP-compatible display.	—
"Snowy"-noise video is output.	It is possible that the HDMI signal is not being sent and received correctly.	Reconnect the HDMI cable.	—
Colors are incorrect.	Does the color space setting on the output-destination equipment (external display, projector, or other such device) match the color space setting on the V-1HD?	Go to the SETUP menu and make the setting for "OUTPUT COLOR SPACE" (OUTPUT connector) or "PREVIEW COLOR SPACE" (PREVIEW connector).	—
		Depending on the device, the color space might be interlinked with the selection of DVI or HDMI or the selected format. In such cases, changing the color space on the output device might bring about improvement for the problem.	—
The edges of video shown on the display are cut off.	Are the display settings compatible?	Depending on the device, the display might automatically overscan. Change the display's settings.	—
Switching video is not possible.	Is a menu (SETUP, MEMORY, or AUDIO) displayed?	Video-switching operations cannot be performed while a menu is displayed. Exit the menu screen.	—
Compositing a logo or text is not possible.	Has the effect been selected correctly?	<ul style="list-style-type: none"> Select "WHT-L.KEY" (white) or "BLK-L.KEY" (black) luminance key to match the background color of the logo or text. Use the to adjust the position to just the right degree of extraction for the logo or text. 	p. 22
Audio-related Problems			
No audio is output. Audio volume is low.	Is the volume turned down on the connected amplifications or speakers?	Adjust to an appropriate volume level.	—
	Is the volume turned down on the V-1HD?	Adjust each input-audio stream to an appropriate volume level. Also, adjust the overall volume level.	p. 25
	Are you using connection cables that contain resistors?	If this happens, use connector cables that do not contain resistors.	—
No reverb is applied.	Is the amount of audio sent to Reverb set at an appropriate level?	If the send level for audio to Reverb is too low, the amount of reverb effect might be difficult to discern. Adjust the send level of the audio to Reverb.	p. 27

Menu List

* The menu is shown on the monitor connected to the PREVIEW connector (p. 9).

MEMORY Menu ((MEMORY) button → [A-1]–[A-4] and [B-1]–[B-4] buttons)

Setting item	Value	Explanation
MEMORY1–MEMORY8		
EFFECTS A	NEGATIVE, EMBOSS, COLORIZE, COLORPASS, POSTERIZE, SILHOUETTE, MONOCOLOR, FINDEEDGE, FLIP, WHT-L.KEY(*1), BLK-L.KEY(*1), GRN-C.KEY(*1), BLU-C.KEY(*1), PinP 1/4(*1), PinP 1/2(*1), SPLIT-VS(*1), SPLIT-VC(*1), SPLIT-HS(*1), SPLIT-HC(*1)	This specifies the effect assigned to the EFFECTS A [ON] button.
EFFECTS B	NEGATIVE, EMBOSS, COLORIZE, COLORPASS, POSTERIZE, SILHOUETTE, MONOCOLOR, FINDEEDGE, FLIP, WHT-L.KEY(*1), BLK-L.KEY(*1), GRN-C.KEY(*1), BLU-C.KEY(*1), PinP 1/4(*1), PinP 1/2(*1), SPLIT-VS(*1), SPLIT-VC(*1), SPLIT-HS(*1), SPLIT-HC(*1)	This specifies the effect assigned to the EFFECTS B [ON] button.
WIPE	H-DOWN, H-UP, V-RIGHT, V-LEFT, V-IN, V-OUT, H-IN, H-OUT, R-DOWN, L-DOWN, R-UP, L-UP, BLOCK, V-GRID, H-GRID, H-DOWN/s, H-UP/s, V-RIGHT/s, V-LEFT/s, H-IN/s, H-OUT/s, V-IN/s, V-OUT/s, R-DOWN/s, L-DOWN/s, R-UP/s, L-UP/s, BLOCK/s, V-GRID/s, H-GRID/s	This specifies the transition pattern assigned to the [WIPE] button. (*2) * Setting values indicated with “/s” are soft edge transition patterns.
MIX	MIX, FAM, NAM, MOSAIC	This specifies the transition pattern assigned to the [MIX] button. (*2)
TRANSFORMER A	NONE, TRANSFORM, ←, ←→, WHITE, BLACK, BPM SYNC, WIPE, MIX, CUT, EFFECTS	This specifies the Function assigned to the TRANSFORMER [▲] button.
TRANSFORMER B	NONE, TRANSFORM, ←, ←→, WHITE, BLACK, BPM SYNC, WIPE, MIX, CUT, EFFECTS	This specifies the Function assigned to the TRANSFORMER [▼] button.
TRANSFORM TIME	0.0–4.0 sec, BPM x 1/4, BPM x 1/2, BPM x 1, BPM x 2	This sets the length of time for applying a video transition.

(*1) When effects are turned on for either bus A or bus B, no effects can be applied to the other bus

(*2) For more information about transition patterns, refer to “Transition Effects List” (p. 35).

MEMORY 1–8 Factory-default Values

MEMORY Menu

	EFFECTS A	EFFECTS B	WIPE	MIX	TRANSFORMER A	TRANSFORMER B	TRANSFORM TIME
MEMORY 1	COLORPASS	FLIP	V-RIGHT/s	MIX	←	←	1.0
MEMORY 2	NEGATIVE	COLORIZE	BLOCK/s	MIX	←	←	2.0
MEMORY 3	PinP 1/2	PinP 1/2	H-UP	FAM	TRANSFORM	TRANSFORM	1.0
MEMORY 4	PinP 1/4	PinP 1/4	V-RIGHT	FAM	←→	←→	1.0
MEMORY 5	WHT-L.KEY	WHT-L.KEY	H-IN/s	NAM	←→	←→	2.0
MEMORY 6	GRN-C.KEY	GRN-C.KEY	V-IN/s	NAM	WHITE	BLACK	1.0
MEMORY 7	SPLIT-VC	SPLIT-HC	H-GRID/s	MOSAIC	BPM	BPM	1.0
MEMORY 8	POSTERIZE	SILHOUETTE	V-GRID/s	MOSAIC	EFFECTS	EFFECTS	1.0

Appendices

AUDIO Menu ([AUDIO] Button)

* The default value is printed in bold characters.

Setting item	Value	Explanation
MEMORY1–MEMORY8		
HDMI IN 1 : HDMI IN 4 AUDIO IN MIC	LEVEL 0– 100 –127	This adjusts the volume level of the respective input audio streams. * 100 = 0.0 dB, 127 = +6.0 dB
MASTER OUT LEVEL	0– 100 –127	This adjusts the volume level of output audio. * 100 = 0.0 dB, 127 = +6.0 dB
AUDIO FOLLOW	ON, OFF	This sets the Audio Follow feature on or off.
HDMI IN 1 : HDMI IN 4 AUDIO IN MIC	EQ Hi EQ Hi FREQ EQ Mid EQ Mid FREQ EQ Mid Q EQ Lo EQ Lo FREQ DELAY	-15 dB– 0 dB –15 dB 700 Hz– 8.00 KHz –11.0 KHz -15 dB– 0 dB –15 dB 20.0 Hz– 2.50 KHz –10.0 KHz 0.5 –16.0 -15 dB– 0 dB –15 dB 55 Hz– 110 Hz –800 Hz This adjusts the delay time for audio.
MIC COMP	ON, OFF	This sets the compressor on or off.
MIC COMP-THRESHOLD	-50 dB– -16 dB –0 dB	This sets the level used as the threshold when compressing audio. Compression is applied to audio that exceeds the level set here.
MIC COMP-RATIO	1.0:1– INF:1	This specifies the degree of compression applied to the audio. The state in which no compression is applied is defined as "1."
MIC COMP-ATTACK	0.2 ms– 50 ms –100 ms	This sets the time until compression starts when audio exceeding the threshold is input.
MIC COMP-RELEASE	30 ms– 500 ms –5000 ms	This adjusts the length of time until compression ends after audio falls below the threshold.
MIC GATE	ON, OFF	This sets gate on or off.
MIC GATE-THRESHOLD	-50 dB– -36 dB –0 dB	This sets the level used as the threshold for removing audio. Audio below the level set here is removed.
MIC GATE-RELEASE	30 ms– 800 ms –5000 ms	This adjusts the length of time until the audio is fully attenuated after audio falls below the threshold.
MIC HPF	ON, OFF	This sets the high-pass filter on or off.
MAIN EQ Hi	-15 dB– 0 dB –15 dB	This boosts or attenuates the high band.
MAIN EQ Hi FREQ	700 Hz– 8.00 KHz –11.0 KHz	This adjusts the center frequency when changing the sound quality in the high band.
MAIN EQ Mid	-15 dB– 0 dB –15 dB	This boosts or attenuates the middle band.
MAIN EQ Mid FREQ	20.0 Hz– 2.50 KHz –10.0 KHz	This adjusts the center frequency when changing the sound quality in the middle band.
MAIN EQ Mid Q	0.5 –16.0	This adjusts the width of the frequency band when boosting or attenuating the middle band.
MAIN EQ Lo	-15 dB– 0 dB –15 dB	This boosts or attenuates the low band.
MAIN EQ Lo FREQ	55 Hz– 110 Hz –800 Hz	This adjusts the center frequency when changing the sound quality in the low band.
HDMI IN 1 : HDMI IN 4	REV SEND 0– 100 –127	This adjusts the send level of audio to Reverb.

Setting item	Value	Explanation
AUDIO IN MIC	REV SEND 0– 100 –127	This adjusts the send level of audio to Reverb.
REVERB LEVEL	0 –127	This adjusts the return level from reverb of the audio. A setting of “0” results in no reverb applied.
REVERB TIME	0.0 sec– 1.0 sec –5.0 sec	This adjusts the length of the reverb.
REVERB TYPE	ROOM , HALL	This specifies the type of reverb.
MASTERING	ON, OFF	This switches mastering on and off.
MASTERING NS	0 –127	This adjusts the degree of application of the noise suppressor.
MASTERING ENHANCER	0 –127	This adjusts the degree of application of the enhancer.
MASTERING HI	0 –127	This suppresses high-frequency distortion and adjusts the sound to have sustained tones.
MASTERING Mid	0 –127	This suppresses midrange distortion and adjusts the sound to have distinct tones.
MASTERING Lo	0 –127	This suppresses low-frequency distortion and adjusts the sound to have stable tones.
A. FOLLOW AUDIO IN	1–4, OFF	This sets the video channel to interlink by Audio Follow with audio input via AUDIO IN. * This is effective when “AUDIO FOLLOW” is set to “ON.”
A. FOLLOW MIC	1–4, OFF	This sets the video channel to interlink by Audio Follow with audio input via MIC. * This is effective when “AUDIO FOLLOW” is set to “ON.”

SETUP Menu (Pressing and holding the [(TAP) BPM] button for 2 seconds or longer)

* The default value is printed in bold characters.

Setting item	Value	Explanation
BPM	20– 120 –250	This sets the tempo when the BPM sync function is turned on.
BPM SYNC	x1/4, x1/2, x1 , x2	When the BPM sync function is turned on, this sets the multiple of the BPM value to be used as the speed to switch is switched.
HDCP	ON, OFF	When set to “ON,” copyright-protected (HDCP) video can be input. HDCP is also added to the video that is output.
OUTPUT CONTRAST	–64– 0 –63	This adjusts the contrast of the main output video.
OUTPUT SATURATION	–64– 0 –63	This adjusts the color saturation of the main output video.
OUTPUT BRIGHTNESS	–64– 0 –63	This adjusts the brightness of the main output video.
OUTPUT COLOR SPACE	AUTO , RGB-FULL, RGB-LIMIT, YPbPr	This sets the color space (system for representing colors in video) of the OUTPUT connector.
OUTPUT DVI-D/HDMI	AUTO , DVI-D, HDMI	This sets the output mode of the OUTPUT connector.
PREVIEW CONTRAST	–64– 0 –63	This adjusts the contrast of the preview output video.
PREVIEW SATURATION	–64– 0 –63	This adjusts the color saturation of the preview output video.
PREVIEW BRIGHTNESS	–64– 0 –63	This adjusts the brightness of the preview output video.
PREVIEW COLOR SPACE	AUTO , RGB-FULL, RGB-LIMIT, YPbPr	This sets the color space (system for representing colors in video) of the PREVIEW connector.
PREVIEW DVI-D/HDMI	AUTO , DVI-D, HDMI	This sets the output mode of the PREVIEW connector.
PREVIEW OUT	MULTI-VIEW , OUTPUT, PREVIEW	This sets the view mode of preview output.
PinP BORDER	0 –3–15	This adjusts the width of the border added to the PinP inset screen.
PinP BORDER COLOR	BLACK, WHITE , GRAY, RED, GREEN, BLUE, YELLOW	This specifies the color of the border added to the PinP inset screen.
AUTO SCAN	ON, OFF	This sets the Auto Scan function on or off. When set to “ON,” channels 1 through 4 are switched automatically.
AUTO SCAN TIME	0 sec– 5 sec –120 sec	When the Auto Scan function is on, this sets the video display interval.

Appendices

Setting item	Value	Explanation								
AUTO SCAN TRANS TIME	0.0 sec– 0.5 sec –4.0 sec	When the Auto Scan function is on, this sets the length of time for applying a video transition.								
A/B MODE	A/B , PGM/PST	This sets the operation mode for video transitions.								
FREEZE MODE	ALL , SELECT	This sets the operation mode for freezes.								
NO SIGNAL BACK	BLACK , BLUE	This sets the background color of channels that have no video input.								
UNFIT SIGNAL BACK	BLACK, BLUE, THRU	This sets the background color of channels on which video of an incompatible format is input. When set to “THRU,” video in an unsupported format is output unchanged, allowing confirmation of the status of the input signal. Note, however, that the video might contain additional noise artifacts.								
DEINTERLACE MODE	WEAVE, BOB	This specifies the method used when converting interlaced input video to progressive video.								
COLOR BAR OUTPUT	ON, OFF	Setting this to “ON” outputs a color bar.								
TEST TONE OUTPUT	ON, OFF	Setting this to “ON” outputs a test tone.								
MIDI Rx SOURCE										
MIDI OUT										
MIDI Tx CHANNEL		For information on remote control via MIDI, download and refer to the “V-1HD Remote Control Guide” (PDF) from the following Roland website.								
MIDI DEVICE ID										
MIDI Rx CHANNEL		http://proav.roland.com								
MIDI Rx TEMPO CLOCK										
POWER ON LOAD	1 –8	Selecting a memory number causes the settings at the selected memory number to be recalled at startup.								
PGM LED	RED , GREEN, YELLOW, BLUE, PURPLE, L.BLUE, WHITE	This specifies the color used when the output video channel buttons ([A-1]–[A-4], [B-1]–[B-4]) light up.								
PST LED	RED, GREEN , YELLOW, BLUE, PURPLE, L.BLUE, WHITE	This specifies the color used when the buttons for the video channel to output next ([A-1]–[A-4], [B-1]–[B-4]) light up.								
INPUT LED	ON , OFF	When set to “ON,” the [A-1]–[A-4] and [B-1]–[B-4] buttons light up, flash, and go dark as shown below.								
		<table border="1"> <thead> <tr> <th>Button</th> <th>Input video status</th> </tr> </thead> <tbody> <tr> <td>Lighted in white</td> <td>Valid video is input.</td> </tr> <tr> <td>Flashing in white</td> <td>Video whose format differs from the [FORMAT] switch setting is input.</td> </tr> <tr> <td>Dark</td> <td>No video is input.</td> </tr> </tbody> </table>	Button	Input video status	Lighted in white	Valid video is input.	Flashing in white	Video whose format differs from the [FORMAT] switch setting is input.	Dark	No video is input.
		Button	Input video status							
		Lighted in white	Valid video is input.							
Flashing in white	Video whose format differs from the [FORMAT] switch setting is input.									
Dark	No video is input.									
TRANSFORMER LED	ON , OFF	When set to “ON,” the TRANSFORMER buttons light up in white.								
AUDIO LED	MASTER OUT , MIC, AUDIO IN, HDMI 1, HDMI 2, HDMI 3, HDMI 4	This specifies the audio signal monitored by the AUDIO indicator.								
MEMORY PANEL LOAD	ON, OFF	This sets whether the state of the operation panel is updated (ON) or not updated (OFF) when a memory is recalled.								
EFFECTS TYPE CHANGE	ON , OFF	When set to “ON,” effect assignments are changed by holding down the EFFECTS A [ON] button and turning the [EFFECTS A] knob. Operation for EFFECTS B is the same.								
WIPE TYPE CHANGE	ON , OFF	When set to “ON,” the wipe transition pattern changes with each press of the [WIPE] button.								
MIX TYPE CHANGE	ON , OFF	When set to “ON,” the mix transition pattern changes with each press of the [MIX] button.								
AUTO OFF	ON , OFF	This sets the Auto Off function on or off. When set to “ON,” the power to the V-1HD is automatically turned off if 240 minutes elapse with no operation performed on the unit.								
FRAME RATE	59.94, 50	This sets the frame rate.								
FACTORY RESET	—	This returns the unit to its factory defaults.								
VERSION	—	This displays the version of the system program.								

Transition Effects List

MIX



Effect	Explanation
MIX	As the original picture gradually disappears, the next video is overlaid and progressively grows more visible.
FAM	Video transitions are made with the luminance levels of the two video streams maintained unchanged. * This is an abbreviation of "full additive mix."
NAM	The two video streams are compared, and transitions are made with display during transition starting with levels of high luminance. * This is an abbreviation of "non-additive mix."
MOSAIC	Transitions are made with mosaic pixelation.

WIPE

The original video is broken into by the next video.

Normal

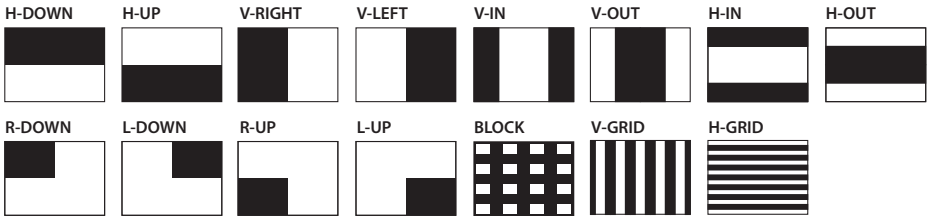

Soft Edge

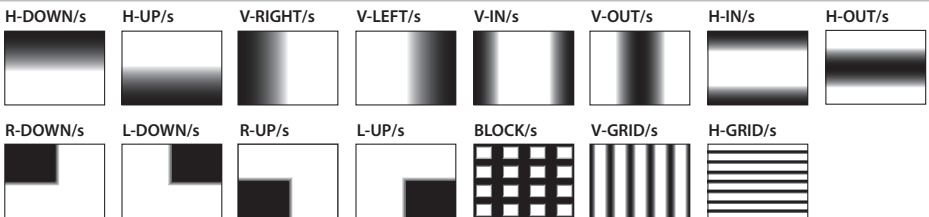

Block Diagram

Video Block

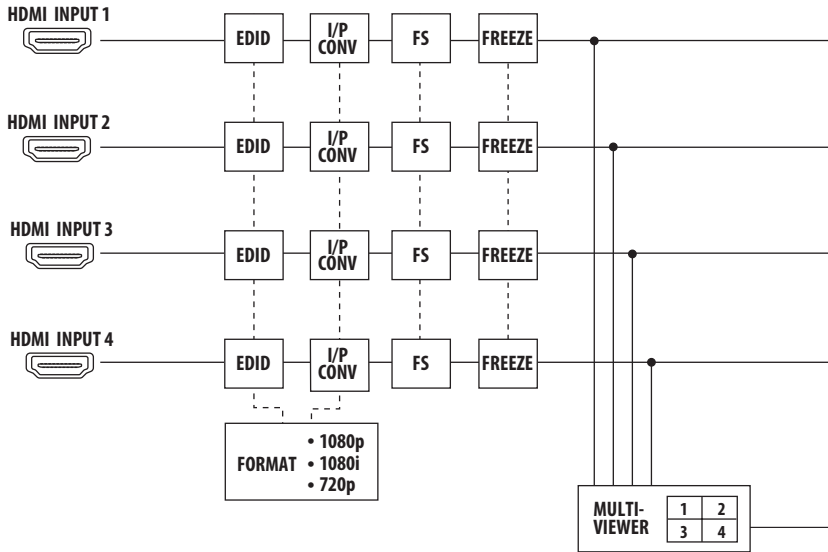

Audio Block

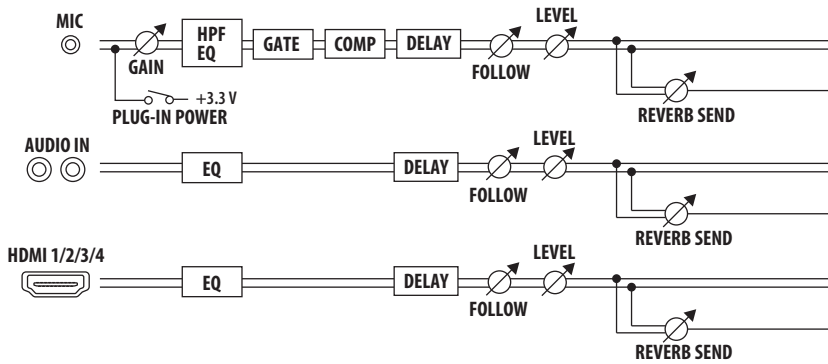

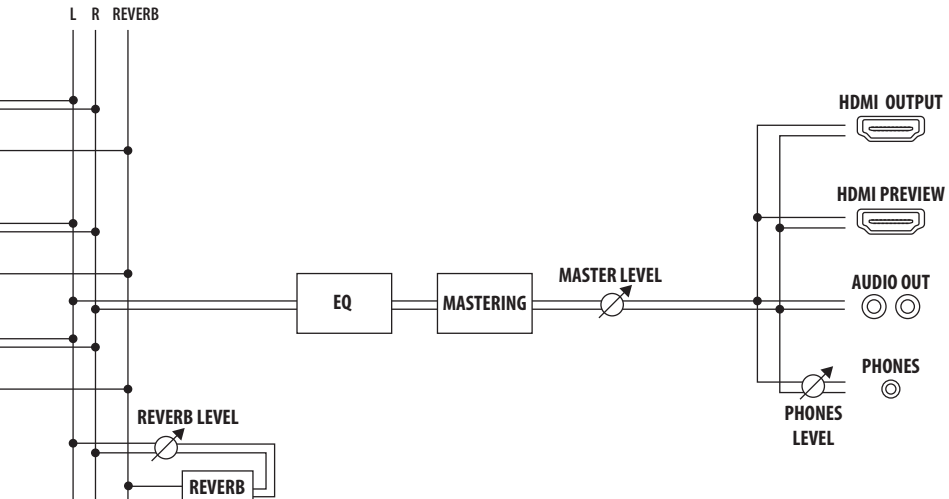
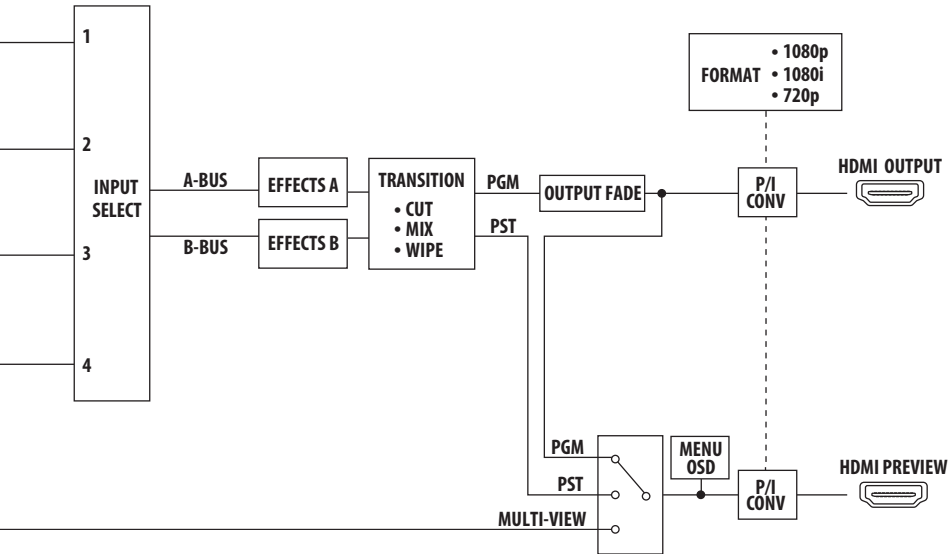

Main Specifications

■ Video		
Video Processing		4:2:2 (Y/Pb/Pr), 8-bit
Input Connectors	HDMI INPUT 1-4	Type A (19 pins) x 4 * HDCP Supported
Output Connectors	HDMI OUTPUT	Type A (19 pins) * HDCP Supported
	HDMI PREVIEW	Type A (19 pins) * HDCP Supported
Input formats	HDMI	720/59.94p, 720/50p (FORMAT switch = 720p)
		1080/59.94i, 1080/50i 1080/59.94p, 1080/50p (FORMAT switch = 1080i or 1080p)
		* The input interlaced video signal is converted to progressive video signal by internal processing. * The video signal frame rate is selected by SETUP parameters (59.94 or 50).
Output formats	HDMI	720/59.94p, 720/50p (FORMAT switch = 720p)
		1080/59.94i, 1080/50i (FORMAT switch = 1080i)
		1080/59.94p, 1080/50p (FORMAT switch = 1080p) * The video signal frame rate is selected in SETUP parameters (59.94 or 50).
Video Effects	Transition	CUT, MIX (DISSOLVE/FAM/NAM/MOSAIC), WIPE (30 types), TRANSFORMER (11 types)
	EFFECTS	NEGATIVE, EMBOSS, COLORIZE, COLORPASS, POSTERIZE, SILHOUETTE, MONOCOLOR, FINDEEDGE, FLIP, WH-LUMIKEY@, BK-LUMIKEY@, GR-CHROMAKEY@, BL-CHROMAKEY@, PinP(1/4)@, PinP(1/2)@, SPLIT(H-STRETCH)@, SPLIT(H-CENTER)@, SPLIT(V-STRETCH)@, SPLIT(V-CENTER)@ * @ marked Effects are effected common to A-BUS and B-BUS.
■ Audio		
Audio Processing	Sampling rate	24 bits/48 kHz
Input Connectors	Digital	HDMI INPUT 1-4 (19 pins) x 4
	Analog	AUDIO IN (RCA pin type) MIC (Stereo mini type, plug-in power supported)
Output Connectors	Digital	HDMI OUTPUT (HDMI Type A 19 pins) HDMI PREVIEW (HDMI Type A 19 pins)
		Analog
	Input Level	AUDIO IN
	MIC	-41 - -13 dBu (Maximum : -1 dBu)
Input Impedance	AUDIO IN	15 k ohms
	MIC	10 k ohms
Output Level	AUDIO OUT	-10 dBu (Maximum : +8 dBu)
	PHONES	72 mW + 72 mW (32 ohms)
Output Impedance	AUDIO OUT	1k ohms
	PHONES	10 ohms
Audio Effects		EQ, Delay, Compressor, HPF, Gate, Reverb, Mastering effect
■ Other Connectors		
USB		B Type (for remote control from PC)
MIDI		IN, OUT/THRU
■ Other Functions		
MEMORY (8 types), FREEZE (input video captured), BPM SYNC (auto transition synchronized to tempo), OUTPUT FADE (WHITE/BLACK)		

■ Others	
Power Supply	AC Adaptor
Current Draw	1.5 A
Power Consumption	18 W
Operation Temperature	+0 to +40 degrees Celsius +32 to +104 degrees Fahrenheit
Dimensions	313 (W) x 102 (D) x 59 (H) mm 12-1/3 (W) x 4 (D) x 2-1/3 (H) inches
Weight	1.2 kg (excluding AC adaptor) 2 lbs 10-2/5 oz
Accessories	Owner's Manual, AC Adaptor, Power Cord, Cord Hook

* 0 dBu=0.775 Vrms

* In the interest of product improvement, the specifications and/or appearance of this unit are subject to change without prior notice.

Dimensions

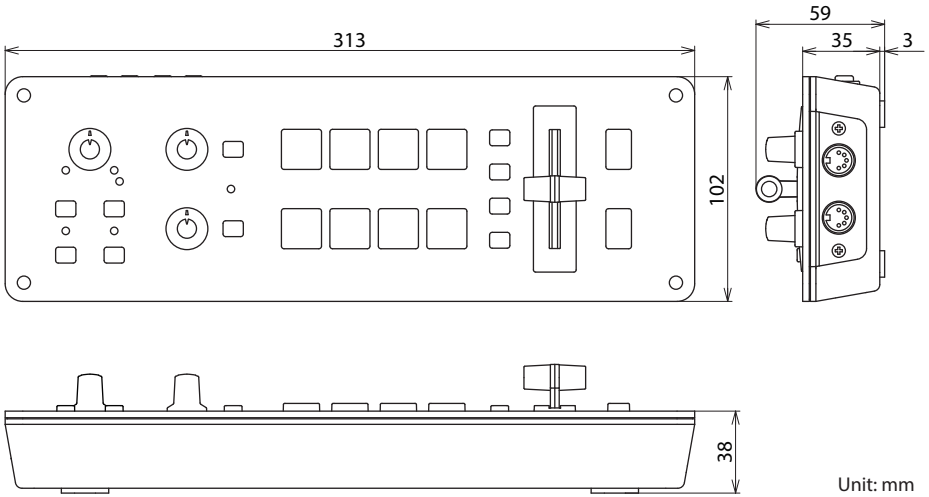

Unit: mm

For the U.K.

IMPORTANT: THE WIRES IN THIS MAINS LEAD ARE COLOURED IN ACCORDANCE WITH THE FOLLOWING CODE.

BLUE: NEUTRAL
BROWN: LIVE

As the colours of the wires in the mains lead of this apparatus may not correspond with the coloured markings identifying the terminals in your plug, proceed as follows:

The wire which is coloured BLUE must be connected to the terminal which is marked with the letter N or coloured BLACK. The wire which is coloured BROWN must be connected to the terminal which is marked with the letter L or coloured RED. Under no circumstances must either of the above wires be connected to the earth terminal of a three pin plug.

For the USA

DECLARATION OF CONFORMITY Compliance Information Statement

Model Name : V-1HD
Type of Equipment : HD VIDEO SWITCHER
Responsible Party : Roland Corporation U.S.
Address : 5100 S. Eastern Avenue Los Angeles, CA 90040-2938
Telephone : (323) 890-3700

For the USA

FEDERAL COMMUNICATIONS COMMISSION RADIO FREQUENCY INTERFERENCE STATEMENT

This equipment has been tested and found to comply with the limits for a Class B digital device, pursuant to Part 15 of the FCC Rules. These limits are designed to provide reasonable protection against harmful interference in a residential installation. This equipment generates, uses, and can radiate radio frequency energy and, if not installed and used in accordance with the instructions, may cause harmful interference to radio communications. However, there is no guarantee that interference will not occur in a particular installation. If this equipment does cause harmful interference to radio or television reception, which can be determined by turning the equipment off and on, the user is encouraged to try to correct the interference by one or more of the following measures:

- Reorient or relocate the receiving antenna.
- Increase the separation between the equipment and receiver.
- Connect the equipment into an outlet on a circuit different from that to which the receiver is connected.
- Consult the dealer or an experienced radio/TV technician for help.

This device complies with Part 15 of the FCC Rules. Operation is subject to the following two conditions:

- (1) this device may not cause harmful interference, and
- (2) this device must accept any interference received, including interference that may cause undesired operation.

This equipment requires shielded interface cables in order to meet FCC class B limit.

Any unauthorized changes or modifications not expressly approved by the party responsible for compliance could void the user's authority to operate the equipment.

For Canada

CAN ICES-3 (B)/NMB-3 (B)

For Korea

사용자 안내문

기종별	사용자 안내문
B 급 기기 (가정용 방송통신기자재)	이 기기는 가정용(B 급) 전자파적합기기로서 주로 가정에서 사용하는 것을 목적으로 하며, 모든지역에서 사용할 수 있습니다.

For C.A. US (Proposition 65)

WARNING

This product contains chemicals known to cause cancer, birth defects and other reproductive harm, including lead.



For EU Countries



- UK** This symbol indicates that in EU countries, this product must be collected separately from household waste, as defined in each region. Products bearing this symbol must not be discarded together with household waste.
- DE** Dieses Symbol bedeutet, dass dieses Produkt in EU-Ländern getrennt vom Hausmüll gesammelt werden muss gemäß den regionalen Bestimmungen. Mit diesem Symbol gekennzeichnete Produkte dürfen nicht zusammen mit den Hausmüll entsorgt werden.
- FR** Ce symbole indique que dans les pays de l'Union européenne, ce produit doit être collecté séparément des ordures ménagères selon les directives en vigueur dans chacun de ces pays. Les produits portant ce symbole ne doivent pas être mis au rebut avec les ordures ménagères.
- IT** Questo simbolo indica che nei paesi della Comunità europea questo prodotto deve essere smaltito separatamente dai normali rifiuti domestici, secondo la legislazione in vigore in ciascun paese. I prodotti che riportano questo simbolo non devono essere smaltiti insieme ai rifiuti domestici. Ai sensi dell'art. 13 del D.Lgs. 25 luglio 2005 n. 151.
- ES** Este símbolo indica que en los países de la Unión Europea este producto debe recogerse aparte de los residuos domésticos, tal como está regulado en cada zona. Los productos con este símbolo no se deben depositar con los residuos domésticos.
- PT** Este símbolo indica que nos países da UE, a recolha deste produto deverá ser feita separadamente do lixo doméstico, de acordo com os regulamentos de cada região. Os produtos que apresentem este símbolo não deverão ser eliminados juntamente com o lixo doméstico.
- NL** Dit symbool geeft aan dat in landen van de EU dit product gescheiden van huishoudelijk afval moet worden aangeboden, zoals bepaald per gemeente of regio. Producten die van dit symbool zijn voorzien mogen niet samen met huishoudelijk afval worden verwijderd.
- DK** Dette symbol angiver, at i EU-lande skal dette produkt opsamlles adskilt fra husholdningsaffald, som defineret i hver enkelt region. Produkter med dette symbol må ikke smides ud sammen med husholdningsaffald.
- NO** Dette symbolet indikerer at produktet må behandles som spesialavfall i EU-land, iht. til retningslinjer for den enkelte regionen, og ikke kastes sammen med vanlig husholdningsavfall. Produkter som er merket med dette symbolet, må ikke kastes sammen med vanlig husholdningsavfall.

- SE** Symbolen anger att i EU-länder måste den här produkten kasseras separat från hushållsavfall. I enlighet med varje regions bestämmelser. Produkter med den här symbolen får inte kasseras tillsammans med hushållsavfall.
- FI** Tämä merkinntä ilmaisee, että tuote on EU-maissa kerättävä erillään kotitalousjätteiltä kunkin alueen voimassa olevien määräysten mukaisesti. Tällä merkinntällä varustettuja tuotteita ei saa hävittää kotitalousjätteiden mukana.
- HU** Ez a szimbólum azt jelenti, hogy az Európai Unióban ezt a terméket a háztartási hulladéktól elkülönítve, az adott régióban érvényes szabályozás szerint kell gyűjtetni. Az ezzel a szimbómmal ellátott termékeket nem szabad a háztartási hulladék közé dobni.
- PL** Symbol oznacza, że zgodnie z regulacjami w odpowiednim regionie, w krajach UE produkty nie należy wyrzucać z odpadami domowymi. Produktów opatrzonych tym symbolem nie można utylizować razem z odpadami domowymi.
- CZ** Tento symbol udává, že v zemích EU musí být tento výrobek sbíráán odděleně od domácího odpadu, jak je určeno pro každý region. Výrobky nesoucí tento symbol se nesmí vyhazovat spolu s domácími odpadem.
- SK** Tento symbol vyjadruje, že v krajínach EÚ sa musí zber tohto produktu vykonávať oddelene od domového odpadu, podľa nariadení platných v konkrétnej krajine. Produkty s týmto symbolom sa nesmú vyhazovať spolu s domovým odpadom.
- EE** See sümbol näitab, et EL-i maades tuleb see toode olemprigist eraldi koguda, nii nagu on igas piirkonnas määratletud. Selle sümboliga märgitud tooteid ei tohi ära visata koos olmeprügiga.
- LT** Šis simbolis rodo, kad ES šalyse šis produktas turi būti surenkamas atskirai nuo buitinių atliekų, kaip nustatyta kiekviename regione. Šiuo simboliu paženklinoti produktai neturi būti išmetami kartu su buitinių atliekais.
- LV** Šis simbols norāda, ka ES valstīs šo produktu jāievāc atsevišķi no mājsaimniecības atkritumiem, kā noteikts katrā reģionā. Produkts ar šo simbolu nedrīkst izmest kopā ar mājsaimniecības atkritumiem.
- SI** Ta simbol označuje, da je treba proizvod v državah EU zbirati ločeno od gospodinjiskih odpadkov, tako kot je določeno v vsaki regiji. Proizvoda s tem znakom ni dovoljeno odlagati skupaj z gospodinjiskimi odpadki.
- GR** Το σύμβολο αυτό υποδηλώνει ότι στις χώρες της Ε.Ε. το συγκεκριμένο προϊόν πρέπει να συλλέγεται χωριστά από τα υπόλοιπα οικιακά απορρίμματα, σύμφωνα με όσα προβλέπονται σε κάθε περιοχή. Τα προϊόντα που φέρουν το συγκεκριμένο σύμβολο δεν πρέπει να απορρίπτονται μαζί με τα οικιακά απορρίμματα.

For China

有关产品中所含有害物质 的说明

本资料就本公司产品中所含的特定有害物质及其安全性予以说明。

本资料适用于 2007 年 3 月 1 日以后本公司所制造的产品。

环保使用期限



此标志适用于在中国国内销售的电子信息产品，表示环保使用期限的年数。所谓环保使用期限是指在自制造日起的规定的期限内，产品中所含的有害物质不致引起环境污染，不会对人身、财产造成严重的不良影响。环保使用期限仅在遵照产品使用说明书，正确使用产品的条件下才有效。不当的使用，将会导致有害物质泄漏的危险。

产品中有毒有害物质或元素的名称及含量

部件名称	有毒有害物质或元素					
	铅(Pb)	汞(Hg)	镉(Cd)	六价铬(Cr(VI))	多溴联苯(PBB)	多溴二苯醚(PBDE)
外壳(壳体)	×	○	○	○	○	○
电子部件(印刷电路板等)	×	○	×	○	○	○
附件(电源线、交流适配器等)	×	○	○	○	○	○

○：表示该有毒有害物质在该部件所有均质材料中的含量均在 SJ/T11363-2006 标准规定的限量要求以下。
 ×：表示该有毒有害物质至少在该部件的某一均质材料中的含量超出 SJ/T11363-2006 标准规定的限量要求。
 因根据现有的技术水平，还没有什么物质能够代替它。

Intellectual Property Right

- It is forbidden by law to make an audio recording, video recording, copy or revision of a third party's copyrighted work (musical work, video work, broadcast, live performance, or other work), whether in whole or in part, and distribute, sell, lease, perform or broadcast it without the permission of the copyright owner.
- Do not use this product for purposes that could infringe on a copyright held by a third party. We assume no responsibility whatsoever with regard to any infringements of third-party copyrights arising through your use of this product.
- This product can be used to record or duplicate audio or visual material without being limited by certain technological copy-protection measures. This is due to the fact that this product is intended to be used for the purpose of producing original music or video material, and is therefore designed so that material that does not infringe copyrights belonging to others (for example, your own original works) can be recorded or duplicated freely.
- MMP (Moore Microprocessor Portfolio) refers to a patent portfolio concerned with microprocessor architecture, which was developed by Technology Properties Limited (TPL). Roland has licensed this technology from the TPL Group.
- This product contains eParts integrated software platform of eSOL Co.,Ltd. eParts is a trademark of eSOL Co., Ltd. in Japan.
- Roland is an either registered trademark or trademark of Roland Corporation in the United States and/or other countries.
- Company names and product names appearing in this document are registered trademarks or trademarks of their respective owners.

 Roland

