



Document MVNManual, Revision Z, 01 04 2021

**xsens**

**MVN User Manual**

Revision	Date	By	Changes
Z	01 04 2021	PHA	MVN 2020.2 release

© 2005-2021, Xsens Technologies B.V. All rights reserved. Information in this document is subject to change without notice. Xsens, Xsens DOT, MVN, MotionGrid, MTi, MTi-G, MTx, MTw, Awinda and KiC are registered trademarks or trademarks of Xsens Technologies B.V. and/or its parent, subsidiaries and/or affiliates in The Netherlands, the USA and/or other countries. All other trademarks are the property of their respective owners.

# Table of Contents

<b>Table of Contents</b> .....	<b>iii</b>
<b>Abbreviations and Terms</b> .....	<b>x</b>
<b>Default Folders</b> .....	<b>xi</b>
<b>1 Introduction</b> .....	<b>1</b>
<b>2 Content overview</b> .....	<b>2</b>
2.1 MVN Link suitcase with contents.....	2
2.2 Motion Tracker (MTx).....	2
2.3 Body Pack (BP), Battery Pack, and Access Point (AP) .....	3
2.4 Cabling .....	3
2.5 MVN Awinda (starter) backpack/suitcase with contents .....	3
2.6 Motion Tracker (MTw) .....	4
2.7 Awinda Station.....	4
2.8 MVN Awinda Charger .....	4
2.9 “The Suit”.....	5
2.10 Motion Trackers on the extremities .....	5
2.11 Software .....	6
<b>3 Getting started</b> .....	<b>7</b>
3.1 Installation of software .....	7
3.2 Preferred language .....	7
3.3 Setup hardware .....	7
3.4 MVN Analyze/Animate workflow overview .....	8
3.5 Tips for best practice .....	9
3.5.1 Operating conditions .....	9
3.5.2 Absolute maximum ratings.....	9
3.5.3 Suit, shirt, short maintenance .....	10
3.5.4 FabriFoam Velcro Straps .....	10
3.5.5 Dynamic movements.....	10
3.5.6 Warming up the motion capture engine .....	10
3.5.7 CH5000 Charger Safety .....	10
<b>4 Software</b> .....	<b>12</b>
4.1 Software Installation.....	12
4.2 Software Activation .....	12
4.2.1 Software License Key .....	12

4.2.2	Dongle License Key .....	12
4.2.3	Network License Key .....	13
<b>5</b>	<b>Hardware .....</b>	<b>14</b>
5.1	MVN Link.....	14
5.1.1	Motion Trackers (MTx).....	14
5.1.2	Body Pack (BP) and Battery .....	14
5.1.3	Battery Charger.....	17
5.1.4	Access Point (AP).....	19
5.1.5	Awinda Station or Sync Station.....	20
5.2	MVN Awinda .....	21
5.2.1	Wireless Motion Trackers (MTw) .....	21
5.2.2	MTw LED Indications .....	21
5.2.3	MTw Stand-by Mode.....	22
5.2.4	Exiting stand-by mode.....	22
5.2.5	Awinda Station .....	22
5.2.6	Awinda Station Synchronization Ports .....	22
5.2.7	Awinda Station Status LED .....	23
5.2.8	Awinda USB Dongle.....	24
5.2.9	Awinda USB Dongle LED .....	24
5.2.10	Powering off MVN Awinda .....	24
5.3	The suit.....	24
5.3.1	Straps .....	24
5.3.2	MVN Lycra suit .....	25
5.3.3	Putting on the remaining Motion Trackers .....	26
5.3.4	Foot pads.....	26
5.3.5	Putting on the Body Pack and Battery Pack .....	26
5.3.6	Tracker locations .....	26
5.4	Connecting the hardware and software .....	27
<b>6</b>	<b>MVN Analyze/Animate .....</b>	<b>28</b>
6.1	Status Bar .....	29
6.2	Command line interface .....	29
<b>7</b>	<b>Workflow and Functionalities in MVN Analyze/Animate .....</b>	<b>30</b>
7.1	New session.....	30
7.1.1	Create a New Recording Session .....	30
7.2	Configure an MVN System .....	31
7.2.1	Enable/disable search for new system .....	31
7.2.2	System Status.....	31
7.2.3	System Name.....	31
7.2.4	View Hardware Status .....	31
7.2.5	Suit Configuration .....	31
7.2.6	Scenario .....	33
7.2.7	Accept Systems .....	33
7.2.8	Max Update Rate .....	33
7.2.9	Body Dimensions .....	33
7.2.10	Props .....	35

7.2.11 Sync .....	37
7.3 General Settings .....	37
7.4 Configuring the Video Camera .....	37
7.4.1 Configuration .....	37
7.5 Configuring the Awinda Station (or Sync Station) .....	39
7.6 Hardware Status .....	40
7.6.1 Relocating motion trackers.....	41
7.6.2 MVN Awinda: Changing Radio Channel .....	42
7.6.3 MVN Awinda: Changing Radio Channel .....	42
7.6.4 MVN Awinda: Reject Unused Trackers.....	42
7.6.5 MVN Awinda: Forget System .....	42
7.7 Navigator .....	43
<b>8 Setup .....</b>	<b>44</b>
8.1 Calibration.....	44
8.1.1 Record and process calibration .....	44
8.1.2 Apply calibration and define x-axis.....	45
8.1.3 Hands-off calibration .....	46
8.1.4 Calibration quality.....	46
<b>9 Preview and Recording .....</b>	<b>48</b>
9.1 Preview .....	48
9.1.1 Viewport Icons .....	49
9.1.2 Views .....	49
9.1.3 Real-time graphs .....	50
9.1.4 Save and Restore Layout .....	51
9.2 Recording.....	51
9.2.1 Note for recording for MVN Awinda Users .....	51
9.3 Add comments after recording .....	52
9.4 Recovery of MVN file after system crash.....	53
9.5 Markers.....	53
9.6 Network Streamer .....	54
9.7 Network Monitor.....	56
<b>10 Playback, reprocessing and editing.....</b>	<b>57</b>
10.1 Reprocess HD .....	57
10.2 Batch Reprocess HD .....	57
10.3 Playback .....	58
10.4 Synchronization with video .....	59
10.5 Contact point editing.....	59
10.5.1 Selection of samples .....	61
10.5.2 Contact point editing options.....	62
10.6 Multi-person editing.....	64

<b>11</b>	<b>On-Body Recording .....</b>	<b>65</b>
11.1	Configuration .....	65
11.2	Calibration and recording .....	65
11.3	Import Recordings .....	65
11.4	Swap Trackers .....	66
11.5	Remote On-Body Recording .....	67
<b>12</b>	<b>3D Position Aiding .....</b>	<b>69</b>
12.1	GNSS.....	69
12.1.1	Introduction .....	69
12.1.2	Set up with GNSS position aiding .....	69
12.2	HTC Vive .....	71
12.2.1	Background.....	71
12.2.2	Vive Hardware placement .....	71
12.2.3	Setting up.....	73
12.2.4	Object tracking.....	76
<b>13</b>	<b>MVN Remote app for iOS and Android .....</b>	<b>77</b>
<b>14</b>	<b>Data Analysis .....</b>	<b>78</b>
14.1	Graphs.....	78
14.1.1	Parameter vs. Time .....	78
14.1.2	Overlay graphs .....	78
14.1.3	Coordination / Phase Plots (Parameter vs. Parameter) .....	78
14.1.4	Graph handling.....	79
14.1.5	Graph toolbar .....	79
14.1.6	Scaling Options .....	79
14.1.7	Zoom .....	80
14.1.8	Pan .....	80
14.1.9	Show/ Hide Legends.....	80
14.1.10	Show Numerical Values on Graphs .....	80
14.1.11	Equal axes .....	80
14.1.12	Amount and layout of graphs.....	81
14.2	Cascade / Tile windows .....	81
14.3	Linked views.....	81
14.4	Marker List .....	81
<b>15</b>	<b>Saving and Exporting .....</b>	<b>82</b>
15.1	BVH.....	82
15.1.1	Frame skip.....	84
15.1.2	Overwrite first frame with T-pose.....	84
15.1.3	Output Presets .....	85
15.1.4	Output Unit.....	85
15.2	C3D.....	85
15.2.1	Points exported in C3D Exporter .....	86

15.3	FBX .....	86
15.4	MVNX .....	87
15.4.1	MVNX backwards compatibility .....	94
15.5	Export Movie.....	95
15.6	Export Excel .....	96
<b>16</b>	<b>Features of MVN Analyze/Animate .....</b>	<b>97</b>
16.1	Plug-ins.....	<b>Error! Bookmark not defined.</b>
16.2	MVN usage statistics .....	97
<b>17</b>	<b>MVN Ethernet Camera.....</b>	<b>98</b>
<b>18</b>	<b>Xsens Peripheral Software.....</b>	<b>99</b>
18.1	Magnetic Field Mapper (MFM).....	99
18.2	Firmware Updater.....	99
18.3	Software Activation Tool: Offline License Activation or Updating a License .....	99
18.3.1	Step 1: Retrieve the license information from a Sentinel protection key .....	99
18.3.2	Step 2: Send the C2V file.....	99
18.3.3	Step 3: Apply the received v2c file using the Software Activation tool.....	99
18.4	Software Activation Tool: Applying an Update .....	100
18.5	RUS Utility: Rehosting a Sentinel protection key.....	100
18.5.1	Step 1: Collect Information about the Recipient Computer .....	100
18.5.2	Step 2: Generate the License Transfer File .....	100
18.5.3	Step 3: Apply the License Transfer File .....	100
18.6	Setup a network license .....	100
<b>19</b>	<b>Troubleshoot.....</b>	<b>102</b>
<b>20</b>	<b>Warranty and liability .....</b>	<b>105</b>
20.1	Customer Support .....	105
<b>21</b>	<b>Regulatory Notices MVN Link.....</b>	<b>106</b>
21.1	Radio Frequency Exposure and Emission .....	106
21.2	CE Declaration of Conformity MVN Link .....	107
21.3	Certificate of Conformity for Radio Equipment in EU.....	108
21.4	FCC Statement.....	109
21.5	FCC Declaration of Conformity MVN Link .....	110
21.6	Certificate of Conformity for Radio Equipment in Japan .....	111
<b>22</b>	<b>Regulatory Notices MVN Awinda .....</b>	<b>112</b>
22.1	Radio Frequency Exposure and Emission .....	112

22.2	CE Declaration of Conformity MTw2, Awinda Station, Awinda Dongle .....	113
22.3	FCC Statements .....	114
22.4	FCC Declaration of Conformity MTw2 .....	115
22.5	FCC Declaration of Conformity Awinda Station .....	116
22.6	FCC Declaration of Conformity Awinda Dongle.....	117
22.7	Certificate of Radio Equipment in Japan MTw2.....	118
22.8	Certificate of Radio Equipment in Japan Awinda Station.....	119
22.9	Certificate of Radio Equipment in Japan Awinda Dongle .....	120
<b>23</b>	<b>Appendices .....</b>	<b>121</b>
23.1	Lycra suit sizes overview .....	121
23.2	MVN kinematics and output .....	121
23.2.1	Quaternion orientation representation .....	121
23.2.2	Conversions .....	122
23.3	Body planes.....	122
23.4	Coordinate systems .....	124
23.5	Anatomical model.....	125
23.5.1	Definition of segment axes.....	125
23.5.2	Bony/anatomical landmarks .....	125
23.6	Segment axes definitions and Origin Definitions .....	128
23.6.1	Spinal segments: L5, L3, T12, T8: Segments 2-5.....	129
23.6.2	Neck: Segment 6 .....	130
23.6.3	Head: Segment 7.....	130
23.6.4	Shoulder: Segment 8 Right and Segment 12 Left.....	130
23.6.5	Upper Arm (Humerus): Segment 9 Right and Segment 13 Left.....	131
23.6.6	Forearm (Radius/Ulna): Segment 10 Right and Segment 14 Left .....	131
23.6.7	Hand: Segment 11 Right and Segment 15 Left .....	131
23.6.8	Upper Leg (Femur): Segment 16 Right and Segment 20 Left.....	132
23.6.9	Lower Leg (Tibia/Fibula): Segment 17 Right and Segment 21 Left .....	132
23.6.10	Foot (Calcaneus): Segment 18 Right and Segment 22 Left.....	133
23.6.11	Toe: Segment 19 Right and Segment 23 Left .....	133
23.7	Joint angles .....	133
23.7.1	Euler Extractions for the joint angles .....	134
23.7.2	Shoulder angle definitions.....	134
23.7.3	Joint angle outputs .....	134
23.8	Xsens motion capture engine .....	134
23.8.1	Height tracking.....	135
23.8.2	Engine settling time .....	135
23.9	Update Rate versus Sample Frequency.....	135
23.10	Strap Down Integration .....	136
23.11	The Awinda Protocol.....	136
23.11.1	Choosing a Radio Channel for MVN Awinda .....	136
23.12	System Specifications .....	138



23.13	System block diagrams .....	143
23.13.1	MTw .....	143
23.13.2	Awinda Dongle.....	143
23.13.3	Awinda Dongle ANT .....	144
23.13.4	Awinda Station .....	144
<b>24</b>	<b>Contact point editing .....</b>	<b>145</b>
<b>25</b>	<b>Synchronization with External Devices .....</b>	<b>146</b>
25.1	The Hardware .....	146
25.1.1	Important note when receiving 5V synchronization pulses.....	146
25.2	Sync In .....	147
25.3	Sync Out .....	148
25.3.1	Settings in MVN Analyze/Animate .....	149
25.4	Important Notices for Sync In .....	149
25.4.1	Sync In Recommended Settings .....	150
25.5	Sync In with MVN Analyze/Animate .....	150
25.6	Sync Out with MVN Analyze/Animate .....	150
25.7	3 <sup>rd</sup> party Synchronization Examples .....	150
25.8	Network sync.....	150
25.9	Gloves .....	151
<b>26</b>	<b>References .....</b>	<b>152</b>

## Abbreviations and Terms

Abbreviation / Term	Description
API	Application Programming Interface
AP	Access Point: The method of transporting data from the body pack to the PC
BP	Body Pack, on-body controller unit for the motion trackers, connects to power and wireless transmission of data to host PC via the Access Point
.BVH	Biovision Hierarchy character animation file format
.C3D	Coordinate 3D export format
Character	Subject in 3D view
.FBX	Filmbox animation file format
IK	Inverse kinematics
MTx	Xsens Inertial and Magnetic Measurement Unit with on-body cables
MTx-STR	String of Xsens Inertial and Magnetic Measurement Units
MTw	Xsens completely wireless Inertial and Magnetic Measurement Unit
MT	Xsens Inertial and Magnetic Measurement Unit (generic reference to MTw or MTx)
MVN	MVN native file format
MVN camera (Ethernet camera)	Physical camera packaged for video reference data
MVN Straps	Velcro straps for attaching MTw to the body
MVN Suit	Lycra suit
MVN system	Complete MVN product (hardware and software)
.MVNA	MVN subject dimensions file
.MVNS	MVN session file
.MVNX	MVN open XML file format
SDK	Software Development Kit
Sensor	Components of the MTx, e.g. gyroscope, accelerometer
Subject	Person in the suit
The suit	MVN Straps and Lycra suit - whichever applies
Motion Tracker	MTw, MTx or MTx-STR
UDP	User Datagram Protocol (for data streaming over Local Area Network (LAN))

# Default Folders

Description	Files	Location
Main program	mvn_studio64.exe	C:\Program Files\Xsens\Xsens MVN <version>\MVN Studio
Documentation	MVN Quick Setup Sheet.pdf	C:\Program Files\Xsens\Xsens MVN <version>\Documentation

## 1 Introduction

The Xsens MVN inertial motion capture system is an easy to use, cost efficient system for full-body human motion capture. MVN is based on Xsens' state-of-the-art miniature inertial sensors and wireless communication solutions combined with advanced sensor fusion algorithms, using assumptions of biomechanical models.

MVN is a completely portable system; it is not restricted to a studio or lab. It can be used anywhere: outside, in the office, and on the work floor. There are no limitations in measurement volume (except the wireless range).

This MVN system is a full body inertial kinematic measurement system, incorporating synchronized video data. Instant graphical output is provided, including joint angles. An additional C3D exporter has been implemented, as well as improved MVNX (XML) output, containing all of the segment information included in the Xsens MVN system as well as joint angle data, center of mass and factory calibrated sensor data.

Examples of fields of use:

- Biomechanics, sport, rehabilitation, ergonomics and human-machine interaction.  
Benefit from the fully ambulant measurement system, advanced functional axes calibration, no need to palpate bony landmarks for marker placement, direct low-noise measurement of acceleration and angular velocity enabling easier internal forces/momentum calculations.
- 3D Animation.  
Enjoy unprecedented ease-of-use, rich and smooth data, very short setup time, and the absence of cumbersome post-processing of markers or lost data.
- Virtual reality, training & simulation.  
Benefit from the highly portable system and a price-point enabling full-body insertion of (multiple) subjects in VR for highest degree of immersion, low-latency smooth motion data.

## 2 Content overview



### 2.1 MVN Link suitcase with contents

Figure	Description
 <p data-bbox="220 819 687 875">Figure 1: Suitcase containing the MVN Link System</p>	<p data-bbox="730 365 1382 510">The MVN Link System arrives in a strong, durable and watertight case. The case has wheels and an extendable handle for easy transportation. The suitcase dimensions meet the requirements for most airline hand-luggage. The suitcase contains:</p> <ul data-bbox="730 510 1390 913" style="list-style-type: none"><li>• 4 MTx String with three trackers</li><li>• 6 Motion Trackers (MTx)</li><li>• 1 Body Pack</li><li>• 1 Battery Pack</li><li>• 1 Battery charger</li><li>• 1 Access Point</li><li>• 1 Upper Body Cable</li><li>• 1 Lower Body Cable</li><li>• 1 Battery Cable</li><li>• 1 Y Cable</li><li>• Lycra suit including headband, gloves, shorts, footpads</li><li>• 1 Segmometer</li><li>• Quick set-up sheet</li></ul>

### 2.2 Motion Tracker (MTx)

Figure	Description
 <p data-bbox="204 1283 528 1339">Figure 2: Motion Tracker (left:MTx, right: MTx-STR)</p>	<p data-bbox="555 1055 1369 1283">The MVN Link system contains two types of motion trackers; the single MTx used as end trackers and the string of three MTx-STR. The motion trackers, MTx, and MTx-STR are the miniature inertial measurement units containing 3D linear accelerometers, 3D rate gyroscopes, 3D magnetometers, and a barometer, which measures atmospheric pressure. These trackers are placed at strategic locations on the body (fixed by the suit), to measure the motions of each body segment.</p> <p data-bbox="555 1283 1353 1429">The MTx trackers are positioned on the pelvis, sternum, hands, and head. The MTx-STR's are used to chain the legs (upper leg, lower leg, and feet), as well as for the upper body (shoulders, upper arms, and fore-arms). For more information about Motion Trackers, see Section 5.1.1.</p>

## 2.3 Body Pack (BP), Battery Pack, and Access Point (AP)



Figure	Description
 <p data-bbox="252 472 560 501">Figure 3: Body Pack (BP)</p>	<p data-bbox="639 322 1382 495">Figure 3 shows the Body Pack (BP). The strings of MTx's are interconnected by the Body Pack. It delivers power from the battery pack to the connected MTx's and retrieves their data ensuring exactly synchronized samples. For more information about the Body Pack, see Section 5.1.2.</p>
 <p data-bbox="240 707 571 736">Figure 4: Access Point (AP)</p>	<p data-bbox="639 530 1382 730">Figure 4 shows the Access Point. The Access Point pairs with the Body Pack to handle the data traffic between the BP and the computer. This Access Point connects to the PC or laptop via Ethernet cable or wirelessly and is powered using a proprietary power adapter or laptop battery. One Access Point can connect to multiple MVN systems. For more information about the Access Point, see Section 0.</p>
 <p data-bbox="212 929 603 958">Figure 5: Battery Pack (Battery)</p>	<p data-bbox="639 754 1382 927">Figure 5 shows the Battery Pack, which connects to the Body Pack via the Battery Cable. The Battery Pack is a single unit made up of 3 Lithium Ion rechargeable cells, and has a typical rating of 10.8V and 2.9Ah. This Battery charges via a single bay standard smart charger and provides up to 9.5 hours of continuous recording time to the system.</p>

## 2.4 Cabling

While transmission from the subject to the PC is completely wireless, there are a number of cables running through the MVN Link suit, connecting the MTx and MTx-STR's to the Body Pack. Additionally, if the user chooses, there is the option of transmitting motion data to the PC from the BP by directly using an Ethernet cable between the Body Pack and the Access Point. This is particularly useful for applications such as skiing or snowboarding, where the wearer of the suit can connect directly to a laptop carried in a backpack.

## 2.5 MVN Awinda / MVN Awinda starter neoprene case with contents



Figure	Description
--------	-------------

 <p>Figure 6: Suitcase containing the MVN Awinda System</p>	<p>The MVN Awinda arrives in durable neoprene case with protective frame, which contains:</p> <ul style="list-style-type: none"> <li>• 17(+1) Wireless Motion Trackers (MTw)</li> <li>• 1 Awinda Station</li> <li>• 2 Awinda Chargers</li> <li>• MTw full body Velcro straps, including 3 shirts, headband, footpads, 2 pairs of gloves</li> <li>• 1 Segmometer</li> <li>• Quick Setup sheet</li> </ul>
 <p>Figure 7: Suitcase containing the MVN Awinda Starter System</p>	<p>The MVN Awinda Starter arrives in durable neoprene shell case with protective frame, which contains:</p> <ul style="list-style-type: none"> <li>• 17 Wireless Motion Trackers (MTw)</li> <li>• 1 Awinda Dongle with Antenna</li> <li>• 6 3-way USB charging cables</li> <li>• 1 6port USB hub</li> </ul> <p>Quick Setup sheet</p>



## 2.6 Motion Tracker (MTw)

Figure	Description
 <p>Figure 8: Motion Tracker (MTw)</p>	<p>Like the MTx, the MTw is a miniature inertial measurement unit containing 3D linear accelerometers, 3D rate gyroscopes, 3D magnetometers, and a barometer. Additionally each MTw contains an internal battery. The trackers are placed at strategic locations on the body (secured by the straps), to measure motion of each body segment. For more details about the MTw, see Section 5.2.1.</p>

## 2.7 Awinda Station / Awinda dongle

Figure	Description
 <p>Figure 9: Awinda Station</p>	<p>The Awinda Station controls the reception of synchronized wireless data from all wirelessly connected MTw's. See Section 5.2 for further details.</p>
 <p>Figure 10: Awinda dongle</p>	<p>The Awinda dongle controls the reception of synchronized wireless data from all wirelessly connected MTw's. See Section 5.2 for further details.</p>

## 2.8 MVN Awinda Charger

Figure	Description
 <p data-bbox="296 400 687 430">Figure 11: MVN Awinda Charger</p>	<p data-bbox="810 253 1362 338">The MVN Awinda Charger is capable of charging six motions trackers. Charging from empty to full takes about one hour.</p>
 <p data-bbox="217 676 767 734">Figure 12: 6 3way usb charging cables plus 6 port USB hub</p>	<p data-bbox="810 448 1362 562">The 6 3way usb charging cables plus the 6 port USB hub are capable of charging 18 motions trackers. Charging from empty to full takes about one hour.</p>

## 2.9 "The Suit"

Depending on the system, either a Lycra suit or a set of mounting straps are provided. The Lycra suit, has been designed for MVN Link and the straps for MVN Awinda and MVN Awinda Starter. The generic term for either mounting type is simply "The Suit". Each mounting system is dedicated to ensuring a good fixation to the body, to minimize skin motion artefact.

For more information about each Suit type see Section 5.3.

MVN Link	MVN Awinda	MVN Awinda Starter
 <p data-bbox="204 1771 580 1800">Figure 13: MVN Link Lycra suit</p>	 <p data-bbox="608 1771 984 1800">Figure 14: MVN Awinda Straps</p>	 <p data-bbox="1054 1756 1347 1814">Figure 15: MVN Awinda Starter Straps</p>

## 2.10 Motion Trackers on the extremities



The motion trackers are secured to the extremities – the head, hands and feet, using a headband, gloves and a foot pads, as can be seen in the figures below.

#### Accessories for placing motion trackers on the extremities



Figure 16: Headband



Figure 17: Gloves



Figure 18: Foot Pads

### 2.11 Software

The MVN system is controlled by a software application called MVN Analyze/Animate. MVN Analyze/Animate is a 64-bit application for Windows 10. There are four versions of MVN Analyze/Animate: MVN Basic, MVN Animate, MVN Animate Pro, and MVN Analyze.

Additional software packages are available for users with specific needs:

For users wishing to use the facilities offered by MVN, such as the biomechanical model and various other dedicated functionalities, for visualizing and collecting data the MVN Software Development Kit (MVN SDK) is available, where users can create their own user interface.

MVN Basic, is our license free version. This version enables the view of recorded files and ability to record files. No exporting or streaming is enabled.

MVN Animate Pro comes enabled with the capabilities of a real-time streaming interface from MVN to Autodesk Motion Builder® and Maya®. Additionally, the MVN remote control and MVN time-code plug-in are enabled for users who wish to accurately measure the time over which recordings are made (for example to facilitate synchronization with other devices such as cameras and audio equipment that also accept time-code as a synchronization means).

To stream to Siemens PLM software, the Siemens Tecnomatix streamer is available with MVN Analyze.

## 3 Getting started

### 3.1 Installation of software

**Note: Do not connect your MVN System (either Access Point or Awinda Station) until software installation is complete (software installation includes installation of relevant drivers which can be finalized, when the hardware is connected).**

Run the downloaded MVN Installer (mvn\_studio#\_setup.exe). Install with "Administrator" rights. Follow the on-screen instructions.

- See 4.1 for details.

### 3.2 Preferred language

The option to present the software in Mandarin, Korean or Japanese, as a replacement of English is available under the preferences tab.

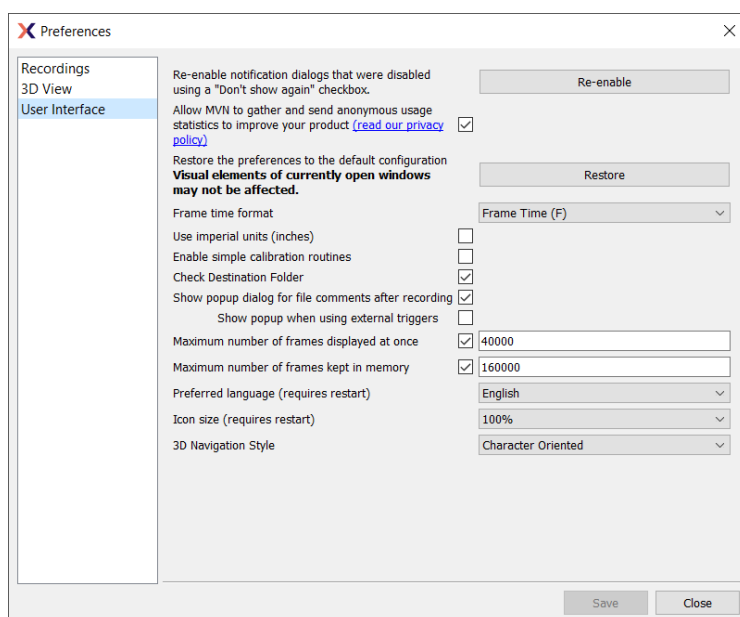

Figure 19: Preferences tab

By clicking in the User Interface section, one can change the language under the preferred language tab. Please note, this will require a restart.

### 3.3 Setup hardware

If using the MVN Link system:







- Connect the Access Point to the computer using the network cable optionally with the Ethernet-to-USB adapter. See Section 0
- After the suit has been put on, connect the head, hands, and feet trackers to the MTx-STR's
- Place the Body Pack on the right and the Battery Pack on the left of the back (for more information on putting on the suit, see section 5.4)
- Connect the Battery Pack and all strings of trackers to the Body Pack

- Press the button on the Body Pack once to power on the device, a pulsing fading LED, solid LED, beep and finally blinking LED indicate the startup process. See Section 5.1.2.

If using the MVN Awinda (starter) system:

- Connect the Wireless Master (see chapter: 2.7) to the computer or laptop
- Turn on the trackers by pressing the button until each LED is activated and begins to flash
- Place the straps and trackers on the body (for more information on putting on the straps, see section 5.4).

### 3.4 MVN Analyze/Animate workflow overview

Icon	Description
	<p><b>Run MVN Analyze/Animate. See Section 7.</b></p> <p>Start a new session. See Section 7.1.1.</p> <p>For MVN Animate Pro or MVN Analyze Pro users requiring additional hardware (reference camera or sync), initialize this hardware at the new session stage.</p> <p>Check the hardware status to make sure that all trackers that are needed for the given configuration have been detected by MVN Analyze/Animate. See Section 7.6.</p>
	<p><b>Calibration. See Section 8.</b></p> <p>For this step users should be in an area where they can walk back and forth for 5-10 meters.</p> <ul style="list-style-type: none"> <li>• Ensure that the 'Hardware and Fusion setup' icon is active in the workflow tool bar.</li> <li>• On the Body Dimensions tab enter the subject height and Foot or Shoe length. See section 7.2.9.</li> <li>• Click the Calibration tab. Select N-pose + Walk and follow the instructions to perform a sensor to segment calibration. Additional calibration poses are also possible if expert calibration routines are enabled. See Section 8.1.</li> <li>• Pay attention to the calibration quality displayed in the Messages for Calibration window before applying the calibration to the character. See Section 8.1.4.</li> </ul>
	<p><b>Preview and Record. See Section 9.</b></p> <ul style="list-style-type: none"> <li>• The live character can be seen in MVN Analyze/Animate viewport. See Section 9.1.</li> <li>• To record a trial, click the red "Record" button. See Section 9.2.</li> </ul>
	<p><b>Playback and editing. See Section 10.</b></p> <ul style="list-style-type: none"> <li>• The recorded trials can be played, using familiar playback buttons. See Section 10.3.</li> <li>• Contact editing is used to manually determine when contact is made between the subject and the surroundings. See Section 10.5.2.</li> </ul>
	<p><b>Analysis. See Section 11.</b></p> <ul style="list-style-type: none"> <li>• Graphical representation of all data, real-time and offline. Section 14.1.</li> </ul>
	<p><b>Saving and Exporting. See Section 15.</b></p> <p>MVN trials are saved directly as files with the .mvn extension. Files with this extension can be opened in MVN Analyze/Animate. Data can also be exported to:</p> <ul style="list-style-type: none"> <li>• <b>BVH</b> (BioVision Hierarchical data) embeds captured motion data in ASCII format which can be imported in many animation applications. BVH requires a strict hierarchical structure, and only relative joint angles can be exported into this file format. This will cause differences between the BVH output and the originally captured motion. See Section 15.1.</li> <li>• <b>C3D</b> (Coordinate 3D) is a format used prolifically in optical systems. The format is coordinate 3D; therefore bony landmark points have been calculated and exported from MVN (virtual marker set). See Section 15.2.</li> <li>• <b>FBX</b> (Filmbox) is a platform-independent 3D file format enabling access to Autodesk software (MotionBuilder or Maya). For some software packages, an FBX plug-in should be installed. FBX files exported from MVN contain position and orientation information of all 23 segments. See Section 15.3.</li> </ul>

- **MVNX** is a human readable, XML format which can be imported to many other software programs, including MATLAB and Excel. This format contains the most information, including the sensor data, segment kinematics and joint angles, as well as the subject information needed to recreate a 3D visualization of a character. See Section 15.4.
- **Movie Exporter** is an mpeg-4 (.mp4 or .avi) video export tool which contains a capture of the character's live motion as configured in the display window.
- **Excel exporter** creates a file which can be opened in Microsoft Excel directly

### 3.5 Tips for best practice

#### 3.5.1 Operating conditions

The recommended operating temperature of the MVN System is between 0°C and +50°C ambient temperature. If operated outside this temperature range performance may decrease or the device might be damaged. Fast transient temperature fluctuations may cause significant temperature gradients across the device. Such gradients cannot be properly modelled by temperature compensation and may therefore decrease performance. For optimal performance the ambient temperature should remain constant as much as possible during the measurement. Please be aware, that for product safety regulations (IEC 62368-1) it is not advised to wear devices on the body at temperatures above 43°C.

The Awinda Station, Awinda USB Dongle, Awinda Chargers, Access Point, Body Pack, Battery Pack, and MT's must be kept **dry** at all times. Condensation and water may damage the internal electronics.

The MT's should be protected from electro static discharges or sources of radiation, as exposure to such sources will damage the internal electronics.

The MT's should be protected from violent handling such as drops on hard surfaces. Excessive shocks or violent handling may damage the MT's. When handling an MT at a desk, it is advised to place cushioning material on the desk.



With MVN Awinda, if it appears that data performance is less than expected, try changing the radio channel to ensure a channel is used with minimal radio interference.

#### 3.5.2 Absolute maximum ratings

Stresses above Absolute Maximum Ratings may cause permanent damage to the device.

Description	Value (MVN Link)	Value (MVN Awinda)
Shock (any axis):	100000 m/s <sup>2</sup> (10000 g) unpowered/powerd	100000 m/s <sup>2</sup> (10000 g) unpowered/powerd
Operating/Storage Temperature:	0 °C - +50 °C	0 °C - +50 °C





Stresses beyond those listed here may cause permanent damage to the device. These are stress ratings only and functional operation of the MT at these or any other conditions beyond those indicated in the specifications are not implied. Exposure to absolute maximum rating conditions for extended periods may affect device reliability.

**Note: Drops onto hard surfaces can cause shocks of greater than 100000 m/s<sup>2</sup> (10000 g) exceeding the absolute maximum rating of the device. Care should be taken when handling to avoid damage. Drops causing shock greater than absolute maximum ratings may not destroy the device but will permanently**

**alter the properties of the physical motion sensors, which may cause the device to become inaccurate.**

### 3.5.3 Suit, shirt, short maintenance

To wash the suit, shirt, shorts **remove all cables, BP and MT's**. Follow the instructions on the label inside the suit:

Description	Icon
Machine wash at 30°C – 85 F	
Do not bleach	
Do not iron	
Do not dry clean	
Do not tumble dry	

For the headband and gloves, remove the MTx and use only cold hand wash.

### 3.5.4 FabriFoam Velcro Straps

Do not place in washing machine or dryer as this may damage the material. Hand wash in warm water. Use mild detergent if soiled. Rinse well. Gently squeeze out excess water. Air dry, foam side up, on rack or towel or hang to dry. It is best to wash regularly to keep the material clean and free of body salts, oils, etc. This will help to prolong material life.

### 3.5.5 Dynamic movements

The MVN Suit/Straps should provide enough fastening for most movements. However, depending on the individual anatomy and fit with the Suit/Straps it might be necessary to take additional steps to ensure that the motion tracker follow the movement of the underlying body segment as well as possible. In particular, for users who will carry out extreme movements, martial art, professional athletes or jumping from heights; it is worth considering applying the provided straps over the Lycra suit as reinforcements to make sure the motion trackers follow the movement of the underlying segment. These straps should be tightly bound tape (be careful to not block the blood circulation!) over the locations of the MT on the body. Additionally, in contact sports or other situations where there is a chance of physical impact it might be beneficial to apply some protective measures (e.g. padding) to protect the person wearing the MVN system as well as the MVN system itself.

### 3.5.6 Warming up the motion capture engine

MVN Analyze/Animate has an advanced motion capture engine that is initialized after the calibration procedure. For best performance, it is recommended to warm up the system, before making recordings. To do so, follow the calibration instructions to stand still when applying the calibration and move rather slowly (e.g. walk around) for approximately the first 30 seconds after applying the calibration. See Section 23.8 and in particular 23.8.2 for more details.

### 3.5.7 CH5000 Charger Safety

- Do not expose the charger or power supply to water or liquids.
- Do not open the charger or power supply case, no user serviceable parts are inside.
- Do not cover the fan exhaust or obstruct the airflow, this will cause overheating.

- Use only the manufacturer's power supply and observe terminal polarity.
- Place the charger in a cool spot, away from external heat sources
- Caution - during recalibration the charger may become warm.

## 4 Software

As mentioned in Section 2.11, the MVN system is controlled by MVN Analyze/Animate. The installer of the software can be downloaded from <https://www.xsens.com/software-downloads>. The instructions below detail the installation procedure.

### 4.1 Software Installation

**Note: Do not connect your MVN System (either Access Point, Awinda dongle, or Awinda Station) until software installation is complete.**

Run the downloaded MVN Installer (setup.exe). Always run installation as a user with “Administrative” rights (by right clicking on icon and selecting “Run as Administrator”).

The MVN Analyze/Animate installer will install:

- MVN Analyze/Animate
- Documentation
- Example files
- Drivers for:
  - Xsens Access Point
  - MTw trackers
  - MVN Awinda Station and Dongle
  - MVN ethernet camera (Allied/Prosilica)
  - Dlink drivers
  - Bonjour drivers
- Software activation tool

**Note: When starting MVN Analyze/Animate for the first time, allow the Windows firewall to give permission to MVN Analyze/Animate to start and connect to the internet.**

Plug-ins, including: MotionBuilder plug-in, Time Code and Remote Control plug-in and MVN SDK are optional. Separate installers are available for the MVN MotionBuilder and Maya plug-ins, the Unity plug-in and the MVN SDK. The Time Code and Remote Control plug-in is part of the MVN Analyze/Animate installer and is activated through licensing.

### 4.2 Software Activation

MVN Analyze/Animate needs to be activated before use. Activation can be done by three types of license keys; Software; Dongle; Network. More information about the licensing can be found in section 18.3. MVN Basic can be used without a license, allowing you to record MVN files.

#### 4.2.1 Software License Key

When using a software license key, license activation is necessary. The Software Activation tool can be started from Start Menu > Xsens MVN 2021.x > Xsens MVN 2021.x > Xsens MVN Software Activation. Follow the on-screen instructions to start the activation, use the product key sent to you by customer service in email and ‘MVN Letter’.

#### 4.2.2 Dongle License Key

Once MVN Analyze/Animate has installed and your license dongle is connected, the software will immediately recognize the license and open MVN Analyze/Animate.

Extension licenses or upgrade licenses can be activated on the dongle using the Software Activation tool, which can be started from Start Menu > Xsens MVN 20xx.x> Xsens MVN 20xx.x > Software Activation.

#### 4.2.3 Network License Key

When using a network license key, the red dongle needs to be used on a pc (server) that is running a service called 'Sentinel LDK License Manager'. This service needs to be started by running an installer, which can be downloaded from:

Xsens website: <https://www.xsens.com/software-downloads>

Look for the download 'Sentinel HASP/LDK - Windows GUI Run-time Installer'.



## 5 Hardware

### 5.1 MVN Link

The standard MVN System consists of a combination of hardware and software. The previous section described how to install the software. The following will provide an overview of the hardware, which includes the MTx's, Body Pack, Sync Station and Access Point; and how to assemble the devices into the mounting system (Lycra suit or MVN Mounting straps).

#### 5.1.1 Motion Trackers (MTx)

The MTx is a complete miniature inertial measurement unit with integrated 3D rate gyroscopes measuring angular velocities 3D linear accelerometers measuring accelerations including gravitational acceleration, 3D magnetometers measuring the (earth) magnetic field, and a barometer to enable measurement of atmospheric pressure.

Two types of motion trackers are integrated in the suit, the MTx, and MTx-STR. These are identical on the inside but have different connectors, as can be seen in Figure 2.

Figure	Description
 Figure 20: MTx2 sensor	<p>The back of the MTx displays various regulatory notices and 2D barcodes used by Xsens for quality control and tracking, as well as the MTx product code (MTx2-4A7G6) and serial number<sup>1</sup> (SN).</p> <p>A Velcro strip is attached to the back of the MTx tracker around the sticker in order to allow for easy mounting of trackers onto the suit.</p>

#### 5.1.2 Body Pack (BP) and Battery

Bodypack	Battery
 Figure 21: Body pack	 Figure 22: Battery

The Body Pack (BP) interconnects multiple strings of MTx's and retrieves their data ensuring exactly synchronized samples. The collected data is transmitted by an optimized 2.4 or 5.0 GHz spread spectrum wireless link to the Access Point connected to the PC or via Ethernet cable.

On the top of the Body Pack there are 4 connectors. With Xsens facing upwards, from right to left:

- The large connector is a 5 pin connector which connects to the Battery Pack cable
- The two central connectors are 5 pin connectors to connect to the strings of trackers

<sup>1</sup> Also known as Device ID.

On the bottom of the Body Pack, there are 3 connectors:

- One Ethernet connector which can be used for cabled recordings, when the system is directly connected to the recording PC rather than transferring data via wireless signal
- A micro USB connector, supported for future use to configure the BP

The BP is powered by a single Battery Pack (rechargeable smart Lithium Ion battery pack). The Battery Pack has a typical operating time of 9.5 hours (using the wireless connection) and can be charged using the provided charger.

#### 5.1.2.1 BP Power on/off and status LED

Each BP has one push button with integrated LED, which controls its power state.

State	Description
Power on:	Press button once, a single beep will sound and the LED will begin to blink slowly: 1 second on, 1 second off
Power off:	Press button <b>three times</b> , three beeps will sound and the LED will stop blinking.

#### 5.1.2.2 BP Status LED

The status LED changes color depending on the BP state.

LED indication	Active mode
Off	Power down
Slow fading flash	Body Pack turning on
Solid	Wireless mode – searching for host
Flashing	Wireless mode – connected to host
Strobe flashing	Wireless mode – sending data

#### 5.1.2.3 Setup for wired connection via Ethernet

This section refers to the wired connection between Body Pack and PC, via Ethernet cable.

MVN is configured to operate in wireless transmission mode by default. However, an Ethernet connection can be made between the BP and the AP in order to directly transfer data to the PC.

**Note: The Ethernet connection should be established prior to turning on the BP.**

#### 5.1.2.4 Running a Wi-Fi Protected Setup (WPS)

In order to establish a connection between a Body Pack and an Access point, users must conduct a Wi-Fi Protected Setup (WPS).

- After the AP is turned on, press and hold the WPS button located on the side of the unit for 2 seconds, until the connection light begins to flash (3 rapid strobes followed by a pause). From the time this flashing begins you have 2 minutes to create a connection with the body pack.
- Next, initialize the Body Pack and wait for the unit to beep and begin searching for a wireless connection. Once the BP is initialized, press and hold the power button for 2 seconds and wait for the LED to begin flashing like the AP LED.

- A successful WPS is indicated by a beep and the BP LED will return to intermittent flashing.

Any Router that supports WPS can be connected to a Body Pack. See the Tutorial video “WPS connection”. Click the address for a direct link to the tutorial.

<https://tutorial.xsens.com/video/wps-connection>

### 5.1.2.5 Soft Access Point

To make the MVN Link system really portable you can connect the Body Pack directly to a laptop or tablet. From within MVN Analyze/Animate you can turn your computer into a wireless access point, which is called ‘Soft Access Point’ it is often also referred to as ‘Virtual Router’. To enable this feature go to Options > Soft Access Point and tick the box.

**Note: To make use of this feature, MVN Analyze/Animate needs to be ‘Run as administrator’.**

See the Tutorial video “Soft Access point connection”. Click the address for a direct link to the tutorial. <https://tutorial.xsens.com/video/soft-accesspoint-connection>

### 5.1.2.6 Wi-Fi Configuration Body Pack

The Body Pack Wi-Fi connection can also be configured manually from the web interface, which can be started from MVN Analyze/Animate. Options > Soft Access Point click ‘Show advanced options’ and then click the button ‘Link configurations’ this will open the web interface for the Body Pack.

Screenshot	Description
 <p>The screenshot shows the web interface for the Xsens Body Pack. It is divided into several sections:         <ul style="list-style-type: none"> <li><b>System Overview:</b> Displays IP Address (172.18.0.1), Subnet Mask (255.255.255.0), Broadcast Address (172.18.0.255), Default Gateway (88.32.70.80), and MAC Address (88:32:70:80:80:40).</li> <li><b>Wireless LAN Settings:</b> Includes fields for IP Address, Subnet Mask, Broadcast Address, Default Gateway, and MAC Address (3C:8A:8C:83:A1:F7).</li> <li><b>Wireless LAN (WLAN) Settings:</b> Shows IP Assignment (DHCP), SSID (Not connected), Channel / Frequency (undefined MHz), Signal strength, and Bit rate.</li> <li><b>Wireless LAN Settings (Advanced):</b> Features a 'Wireless networks' dropdown, 'Connect' and 'Forget Network' buttons, and a 'Wireless Protected Setup (WPS)' section with a 'Start WPS' button.</li> <li><b>Network Settings:</b> Includes 'Frequency Band / PPS for Scan' (Automatic), 'Scan for Networks', 'Wireless Networks' (Scan for Networks to start scan), SSID, Network Key, and Show Network Key.</li> <li><b>IP Settings:</b> Shows IP Assignment (DHCP), IP Address, Subnet Mask, Broadcast Address, and Default Gateway, with a 'Save Settings' button.</li> <li><b>On-Board Recording options:</b> Shows 'USB mode' with 'Enable' and 'Disable' options.</li> </ul> </p>	<p>The web interface consists of a system overview and Wireless LAN Settings.</p> <p>Under the Wireless LAN Settings you can scan and manually connect to a network or start WPS. Here you can also set the Frequency Band and Channel that the Body Pack will scan on. The router determines the Frequency Band and Channel of the connection, setting the Frequency Band and Channel on the Body Pack that matches the settings on the router a connection will be made faster.</p> <p>Static IP address can also be set up here.</p>

Figure 23: Web interface

See the Tutorial video “Manual Wi-Fi connect through Web interface”. Click the address for a direct link to the tutorial. <https://tutorial.xsens.com/video/connect-to-wifi>

### 5.1.3 Battery Charger

The CH5000 is a standalone desktop smart, standard battery charger with the added ability to recalibrate the fuel gauge on smart battery packs.

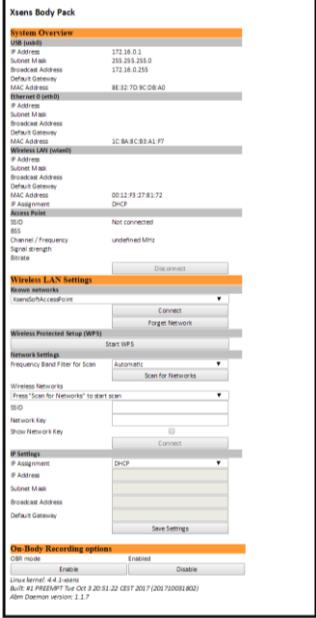
#### 5.1.3.1 Using your Charger

Place the charger on a flat, level surface away from sources of heat and moisture. Plug the DC connector from the power supply into the back of the charger and connect the power supply to the mains AC supply using the cable supplied.

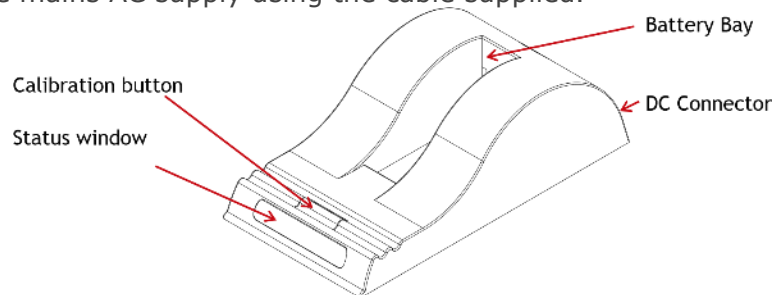

Figure 24: Battery charger

#### 5.1.3.2 Charging

Place the battery into the battery bay ensuring that the 5-way connector is fully seated. The LEDs in the status window will provide status information and the charger will automatically begin charging.

LED Indication:

The status of the battery is indicated by the LEDs visible in the status window:

LED indication	Active mode
Green flashing	Battery charging
Green solid	Battery fully charged
Blue flashing	Battery in calibration mode
Blue solid	Battery fuel gauge calibrated
Red flashing	Battery fuel gauge needs recalibration
Red solid	Error

Recharge and recalibration Time:

The recharge time for the battery (NC2040) is 3 hrs. The time given is for a full charge from 0% to 100% state of charge. Recalibration is 16-20 hrs. A calibration cycle will be faster if the battery is fully charged to begin with.

#### 5.1.3.3 Fuel Gauge Recalibration

If fuel gauge recalibration is needed, the red LED on a calibrating charger will flash upon insertion of the battery. This provides feedback on the accuracy of the fuel gauge.

At this point you can choose to either calibrate the fuel gauge or to charge the battery. Calibration takes longer than charging and it may not be convenient to go through the calibration cycle at that moment.

To recalibrate the fuel gauge, press the button on the front of the charger. The charger will automatically begin to charge the battery if the button is not pressed.

The blue LED will flash to indicate that the battery is undergoing the recalibration cycle. During calibration the discharge resistors will be cooled by the fan. Removing the battery, or pressing the calibration button again will re-start the process from the beginning.

At the end of this procedure the blue LED will stay constant, indicating a fully calibrated fuel gauge. Warm environments can cause calibration failure - keep the charger away from direct sunlight or heat sources.

For more details on smart charging and recalibration go to [www.inspiredenergy.com](http://www.inspiredenergy.com)

**Impedance-Tracking** fuel gauge recalibration is achieved by charging the battery, allowing it to rest, discharging it and allowing it to rest again as shown below:

- Charge the battery to full charge and allow it to rest for at least 5¼ hrs.
- Discharge the battery to empty and allow it to rest for 5¼ hrs
- At this point the fuel gauge is calibrated, but the battery is partially discharged and will require a recharge

The temperature during the process must remain between 10°C & 40°C.

#### 5.1.3.4 What is fuel gauge recalibration and why is it needed?

As the battery ages and is used, its available capacity shrinks - so with each cycle, your device's runtime gets a little bit less.

A good rule of thumb is that Li-Ion batteries lose 5% capacity per 100 cycles & 5% per year.

### 5.1.4 Access Point (AP)

The MVN System comes with one Access Point (AP) which handles the data traffic between the BP and the computer. The Access Point should be connected to the PC via Ethernet cable through the Ethernet port or using the supplied Ethernet to USB adapter.

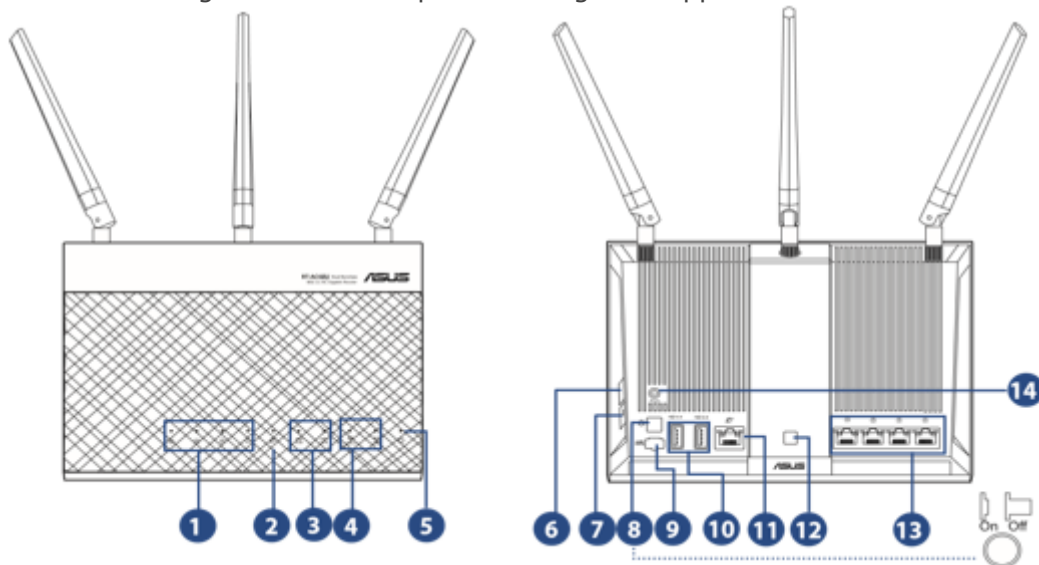

Figure 25: Access point

1. LAN 1~4 LED
  - Off: No power or no physical connection.
  - On: Has physical connection to a local area network (LAN).
4. 2.4GHz LED / 5GHz LED
  - a. Off: No 2.4GHz or 5GHz signal.
  - b. On: Wireless system is ready.
  - c. Flashing: Transmitting or receiving data via wireless connection.
5. Power LED
  - a. Off: No power.
  - b. On: Device is ready.
  - c. Flashing slow: Rescue mode
  - d. Flashing quick: WPS is processing.
6. WPS button
  - a. This button launches the WPS Wizard.
8. Power button
  - a. Press this button to power on or off the system.
9. Power (DC-IN) port
  - a. Insert the bundled AC adapter into this port and connect your router to a power source.
12. LED On/Off button
  - a. Press this button to turn on/off the backlight LED on the panel.
13. LAN 1 ~ 4 ports
  - a. Connect network cables into these ports to establish LAN connection.
14. Reset button
  - a. This button resets or restores the system to its factory default settings

#### 5.1.4.1 Positioning the Access Point

For the best wireless signal transmission between the wireless router and the network devices connected to it, ensure that you:

- Place the wireless router in a centralized area for a maximum wireless coverage for the network devices.
- Keep the device away from metal obstructions and away from direct sunlight.
- Keep the device away from 802.11g or 20MHz only Wi-Fi devices, 2.4GHz computer peripherals, Bluetooth devices, cordless phones, transformers, heavy-duty motors, fluorescent lights, microwave ovens, refrigerators, and other industrial equipment to prevent signal interference or loss.
- To ensure the best wireless signal, orient the three detachable antennas as shown in the drawing below.



Figure 26: Antennas orientation for best wireless signal

**Note: If the AP is connected to the computer through the supplied Ethernet to USB adapter, it will not function when a "Selective Suspend" power management feature is enabled on the PC/Laptop being used for recording. When the AP is used with "Selective Suspend" turned ON, the computer may hang during shutdown or possibly not shutdown correctly. You must therefore disable power management for the USB hub to prevent this.**

To do this, follow these simple steps:

From the Start Menu >Right click on Computer >Manage >Device Manager >Universal Serial Bus Converters >Right click on USB Root Hub >Properties >Power Management.

Uncheck the box "Allow the computer to turn off this device to save power." OK your way out.

**Note: Doing this may significantly reduce laptop battery life.**

### 5.1.5 Awinda Station or Sync Station

Figure	Description
 <p data-bbox="204 1809 518 1877">Figure 27: Awinda station (sync station)</p>	<p data-bbox="563 1653 1390 1749">MVN Link (version 4.1 onwards) supports synchronization with third party devices using an MVN Awinda Station or a Sync Station. The figure to the left shows the BNC connectors of the Awinda Station.</p> <p data-bbox="563 1771 1358 1868">Section 7.5 explains how to set up synchronization of the Awinda Station or Sync Station and Section 25 provides more details and examples with third party systems.</p>

Note that if synchronizing with a third party device sending 5V, it is advised to purchase (from e.g. Farnell) a 3.3 - 5V / 5V - 3.3V SMD level translator to prevent damage to the Sync In ports of the Sync Station.

## 5.2 MVN Awinda / MVN Awinda Starter

### 5.2.1 Wireless Motion Trackers (MTw)

The MTw provides 3D angular velocity using rate gyroscopes, 3D acceleration using accelerometers, 3D earth magnetic field using magnetometers, as well as atmospheric pressure using the barometer. Combined with Xsens algorithms, 3D drift-free orientation is provided. The MTw is an excellent measurement unit for orientation measurement of human body segments, in particular because it is also designed to maintain very high accuracy time synchronization of the individual sensor readout across a wireless network of multiple units. This is essential when measuring joint angles accurately.

The MTw is powered using a LiPo battery. The battery can be in operation for up to 6 hours, and maintain a level of charge in stand-by for approximately 90 hours when in sleep mode. It will be fully recharged after one hour docked in a wall powered Awinda Station. For more technical details on the MTw, sensor component specifications and orientation performance, see Section 23.12.

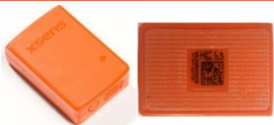
Figure	Description
 <p>Figure 28: MTw</p>	<p>On the top of the MTw is an LED which indicates of device status. The MTw charges via micro USB connection located on its base. Next to this is a power button used to power each MTw on and off.</p> <p>The back of the MTw displays 2D barcodes used by Xsens for quality control and tracking, as well as the MTw product code (MTw2-3A7G6) and serial number<sup>2</sup> (SN).</p> <p>On the side of each MTw is a label indicating the pre-defined on body position.</p> <p>Velcro attached to the back of the MTw tracker allows easy fixation to the straps.</p> <p>The operating frequency of the MTw is 2405 – 2475MHz with a rated conducted RF power of 2 dBm.</p>

### 5.2.2 MTw LED Indications

The following lists the LED indications of the MTw, which are a combination of the device states and the Awinda protocol states of the MTw.

State	Description
Power-up	Blinking.
Docked and fully charged	ON
Charging	Slow fade from ON to OFF as a percentage [%] of battery status. A slow cycle means an almost full battery. A quick cycle means an almost empty battery.
Scanning	Pulsating out of sync with Awinda Station (CONN LED)
Connected	Slow symmetric ON/OFF toggle in sync with Awinda Station (CONN LED).
Measuring	Fast symmetric ON/OFF toggle in sync with Awinda Station (CONN LED).
Battery Low	Quick Triple Pulses, overrides other states until charging again.

<sup>2</sup> Also known as Device ID.



Flushing	Double pulse in sync with Awinda Station (CONN LED).
Stand-by	OFF. Blinks for 3 s, if motion has been detected, while searching for a radio connection.



### 5.2.3 MTw Stand-by Mode

Following a wireless connection to the Awinda Station or Dongle, the MTw enters measurement mode. If the radio of the Awinda Station or Dongle has been switched off for longer than 30 seconds the MTw will enter stand-by mode. In this mode, the MTw will shut down its power and stop the LED blinking, but monitor change in magnetic field every second. See below for exiting standby mode.

### 5.2.4 Exiting stand-by mode

The MTw will monitor its movement, if there is considerable movement, and there is a signal from an Awinda Station or Dongle, the MTw will become active again. To manually bring the MTw out of stand-by mode, reactivate the radio of the Awinda Station, and move the MTw. A simple 90 degree turn or simply lifting it from the suit case to apply to the subject should be enough.

### 5.2.5 Awinda Station

Figure	Description
 <p>Figure 29: Front view of the Awinda station</p>	<p>Front view of the Awinda Station, showing the LEDs. A description of the LEDs is provided in Section 5.2.7 below. On top are docking spaces for 6 MTw's with recessed micro USB connectors. On the side is a foldable and rotatable 2.4 GHz antenna for maximum range.</p> <p>The external antenna of the Awinda Station enables a wireless range indoor/outdoor: 20/50 m (60/150ft).</p> <p>The operating frequency of the Awinda Station is 2405 – 2475MHz with a rated conducted RF power of 19 dBm.</p>
 <p>Figure 30: Back view of the Awinda station</p>	<p>Back view of the Awinda Station, showing the DC power connector, the USB connector and 4 BNC sync I/O connectors for synchronization with external devices.</p>

### 5.2.6 Awinda Station Synchronization Ports

On the back of the Awinda Station there are four BNC ports, two Sync In ports and two Sync Out. The ports have been configured to send (Sync Out) or receive (Sync In) TTL pulses 0-3.3V.









Note that this 3.3V is lower than some devices, which will be synchronized with the MVN System. These other devices use 5V. For this reason it is advised to separately purchase (from eg Farnell) a 3.3 - 5V / 5V - 3.3V SMD level translator. This will prevent damage to the SyncIn ports of the Awinda or Sync Station when receiving 5V pulses from third party systems. In general sending a 3.3V pulse from an Awinda or Sync Station

SyncOut port is fine. Therefore unless a threshold of 5V of the third party system is required, in which case the 3.3V-5V SMD level translator will be required.

For software configuration of the synchronization channels, see Section 25.

### 5.2.7 Awinda Station Status LED



The Awinda Station has five LED indicators. From right to left, these indicators are:

Label	Led	Description
CHRG [CHaRGeR functionality]	OFF	When no mains power supply is connected to the Awinda Station.
		GREEN: When 12V power supply is connected (mains power supply).
STAT [STATus of the Awinda Station]	OFF	OFF: When no power supply is present and when MVN Analyze/Animate is not started. Power is from mains power supply and / or USB.
		GREEN: Both USB connection present and MVN Analyze/Animate running connected to driver.
		ORANGE: USB connection to host PC is present.
		RED: Only power supply connected or error has occurred, e.g., a short-circuit of an MTw.
EXT [EXTeRnal connection]	OFF	Remains off unless external connection made.
		GREEN: External connection e.g. sync port.
CONN	OFF	OFF: No wireless connection.
		GREEN slow blinking: (1 blink per second), radio switched on. When MTw connects, MTw LED and CONN LED blink synchronously. Fast blink: Measurement Mode.
DATA	OFF	OFF: No data received.
		GREEN: Measurement mode.
		ORANGE: Flushing. Flushing is the action of transferring data that has been stored on the MTw buffer, while the MTw was out of range and unable to transfer data in real-time to the Awinda Station.
		RED: Recording mode is active. This allows the remote monitoring that the host PC has initiated a recording successfully.

**Note: The power supply is needed to charge docked MTw's or to change between power off and power on, of docked MTw's. Only the power supply is needed for charging purposes (USB is not needed in this case). Power supply and USB connection are required for firmware updates or location reassignment of MTw's.**

Power supply is not needed for wireless communication (e.g. measurement/recording).

### 5.2.8 Awinda USB Dongle

Figure	Description
 <p>Figure 31: Awinda USB dongle</p>	<p>The Awinda USB dongle has the same wireless capabilities as the Awinda Station, in that it can accurately control the reception of data of up to 32 MTw's.</p> <p>Given that the Dongle does not have an external antenna its range is shorter than the Awinda station; indoor/outdoor 10/25m (30/75ft).</p> <p>The operating frequency of the Dongle is 2405 – 2475MHz with a rated conducted RF power of 2 dBm</p>
 <p>Figure 32: Awinda Dongle ANT</p>	<p>The Awinda Dongle ANT with external antenna has the same radio design and wireless capabilities as the Awinda Station, in that it can accurately control the reception of data of up to 32 MTw's.</p> <p>The Awinda Dongle ANT has a range that is in line with the Awinda Station; indoor/outdoor 20/50m (60/150ft).</p> <p>The operating frequency of the Dongle is 2405 – 2475MHz with a rated conducted RF power of 19 dBm</p>

### 5.2.9 Awinda USB Dongle LED

The Awinda USB dongle has one white LED.

State	Description
Radio Off	LED off.
Scanning for MTw's	Pulsating LED.
Connected	Slow symmetric ON/OFF toggle (MTw blinks in sync with LED of dongle).
Measuring	Fast symmetric ON/OFF toggle (MTw blinks in sync with LED of dongle).

### 5.2.10 Powering off MVN Awinda

Power off the MTw's by clicking on each tracker's power button.

To power off wirelessly, the system should be wirelessly connected. To power off, go to menu >Tasks >Switch Off Hardware. All MTw's will switch off. The MTw LEDs and the CONN LED of the Awinda Station will switch off.

## 5.3 The suit



The MVN system arrives with motion trackers either mounted into a Lycra suit or located in a tray with a set of accompanying MVN straps. The generic term for the straps or the Lycra suit is simply "The Suit". Below a description of how to mount the straps or suit is explained, followed by the advice for the extremities (hands, feet and head), which are the same for both systems.

### 5.3.1 Straps

The MVN Strap set consists of a set of patented non-latex composite material; these are often used in the medical profession, and are safe and hygienic. Additionally zip-fastened T-shirts in three sizes are provided for securing the sternum and shoulders.

Straps are provided as a standard mounting system with MVN Awinda and are useful for interchanging setups between (different sized) subjects.

Straps are suitable for a majority of the adult population and can be placed directly on the skin for the close contact, or on top of the clothing for comfort. If worn over clothing, it is advisable to wear relatively tight-fitting clothes.

Figure	Description																		
 <p>Figure 33: MTw side view</p>	<p>The motion trackers are provided with a code indicating segment position.            'L' or 'R': left or right side of the body.            Segment: An abbreviation of the segment name.</p>																		
 <p>Figure 34: Full body strap set</p>	<p>While the straps are not labelled, the dimensions give an indication of their intended locations.</p> <table border="1"> <thead> <tr> <th>Segment</th> <th>Width (cm)</th> <th>Length (cm)</th> </tr> </thead> <tbody> <tr> <td>Pelvis</td> <td>10</td> <td>140</td> </tr> <tr> <td>Upper Leg</td> <td>10</td> <td>72</td> </tr> <tr> <td>Lower Leg</td> <td>5</td> <td>55</td> </tr> <tr> <td>Upper Arm</td> <td>5</td> <td>55</td> </tr> <tr> <td>Forearm</td> <td>5</td> <td>30</td> </tr> </tbody> </table>	Segment	Width (cm)	Length (cm)	Pelvis	10	140	Upper Leg	10	72	Lower Leg	5	55	Upper Arm	5	55	Forearm	5	30
Segment	Width (cm)	Length (cm)																	
Pelvis	10	140																	
Upper Leg	10	72																	
Lower Leg	5	55																	
Upper Arm	5	55																	
Forearm	5	30																	

### 5.3.1.1 Putting on the Straps

Below are a few simple steps to help put on the straps. It is advised to watch the tutorial video for more detailed and visual information. <https://tutorial.xsens.com/video/placing-straps>

- It is recommended to begin by putting on the top.
- Since the sternum and shoulder trackers are attached to Velcro patches on a zip-fastening t-shirt, it is advised to secure this garment before attaching the upper arm straps.
- For the arms, legs and pelvis: Straps should first be placed (tightly) onto the limb in question, fasten the tracker in place then wrap the remaining length of the strap tightly around the limb and fasten using the Velcro tab.
- It is necessary to have assistance for positioning the motion trackers of the shoulder blades after the zip on the vest has been secured. It is also advisable to have assistance for accurate positioning of the tracker at the pelvis, while the wearer (or second assistant) wraps the remaining length of the strap around the waist.
- Check that the Straps are fastened tightly enough to the body.  
 To do this, the subject wearing the straps should walk, run or perform sample movements to be measured. If the straps become loose, re-tighten them and repeat the check.

**Note: When tightening the straps, pull the strap from the center of the length rather than at the end!**

### 5.3.2 MVN Lycra suit

A Lycra suit is provided with the MVN Link system. The MVN Lycra Suit is available in 6 different sizes (S, M, L, XL, XXL and 4XL). Before putting on a suit, ensure that the size is appropriate. The suit must be tight fitting, therefore choose the appropriate suit size. Note that the fabric is stretchable, a medium size suit can fit to both a short muscular athlete (e.g., 1.60 m, 70 kg) and a tall slim person (e.g., 1.75 m, 65 kg).

Take care when putting on the suit; you are working with delicate materials. The subject is advised to wear closely fitting shorts and a tight shirt underneath the MVN Lycra Suit.

Other clothing can be worn on top, no connection or line-of-sight is needed to the external world other than the wireless data link. Follow these steps to put on the suit:

Important:

- The zip is at the front of the Lycra suit.
- Do not pull aggressively on the material, work gradually from the feet to the neck.

#### 5.3.2.1 Putting on the Lycra suit

Below are a few simple steps to help put on the Lycra suit. Again it is advised to watch the video on the tutorial portal for more detailed, visual information.

<https://tutorial.xsens.com/video/putting-on-lycra-suit>

#### 5.3.2.2 Placing the MT's in the Lycra suit

Upon delivery, the Lycra suit will come with MTx inside already. However, for changing suit sizes or after washing, you will need to put the motion trackers back in the suit. It is advised to do this when the "empty" suit is already on the subject. The video on the tutorial portal shows how to do this best. <https://tutorial.xsens.com/video/preparing-hardware-mvn-link>

#### 5.3.3 Putting on the remaining Motion Trackers

When the suit has been put on, motion trackers for the head, hands and feet will remain outside of the Lycra. The head band is fitted with a Velcro patch, and gloves are fitted with a pocket for motion tracker placement. The motion trackers for the feet are secured to the shoes using foot pads, as described in section 5.3.4.

#### 5.3.4 Foot pads

Dedicated foot pads have been made to facilitate placement of the motion trackers on the feet, these pads can be used with many different types of shoes and remain fixed to the feet, minimizing motion of the tracker on the foot and ensuring reliable motion capture data and foot contact detection.

Figure	Description
 <p data-bbox="363 1485 619 1516">Figure 35: Foot pads</p>	<p data-bbox="807 1314 1388 1516">To use, place the pads with the motion tracker attached onto the bridge of the foot, tongue of the shoe. It is best to push this a little further to the front of the foot, since when the shoes are fastened, it can slip upwards. Make sure the shoe fastening e.g. prevent the tracker from shifting within the shoe.</p>

#### 5.3.5 Putting on the Body Pack and Battery Pack

The Body and Battery Packs are placed into the pockets at the back of the Lycra suit. While it is not crucial, it is more comfortable if you the Body Pack is on the right and the battery on the left.

#### 5.3.6 Tracker locations

The placement of the motion trackers onto the correct segment is very important, as each tracker has a given ID, which is used throughout the motion capturing procedure. Additionally, it is important that the motion trackers are positioned on the segment in a place where maximal range of motion and a minimal amount of skin motion artefact occurs. When wearing the Lycra suit, it is more likely that the MTx's are positioned

correctly than with the Straps. Therefore please refer closely to the following information to ensure the best placement. The table below describes the positioning of the motion trackers.

Location	Abbreviation	Optimal position
Foot	FOOT	Middle of bridge of foot
Lower leg	lLEG	Flat on the shin bone (medial surface of the tibia)
Upper leg	uLEG	Lateral side above knee
Pelvis	PELV	Flat on sacrum
Sternum	STERN	Flat, in the middle of the chest
Shoulder	SHOU	Scapula (shoulder blades)
Upper arm	uARM	Lateral side above elbow
Fore arm	fARM	Lateral and flat side of the wrist
Hand	HAND	Backside of hand
Head	HEAD	Any comfortable position

Watch the video on the tutorial portal for instructions on how to put place the MTw's on the straps. <https://tutorial.xsens.com/video/preparing-hardware-mvn-awinda>

#### *5.4 Connecting the hardware and software*

To connect the hardware and software, connect to the Access Point or plug the Awinda Station into the USB port of the pc. When using the MTx, make sure that the BP is switched on. Start MVN Analyze/Animate to begin working with the system.

## 6 MVN Analyze/Animate

MVN Analyze/Animate is easy-to-use software, which can be used for real-time viewing and recording. Off-line playback, analyzing and editing of previously recorded sessions are also possible with MVN Analyze/Animate. Figure 36 shows a typical view of MVN Analyze/Animate when a recording has been made.

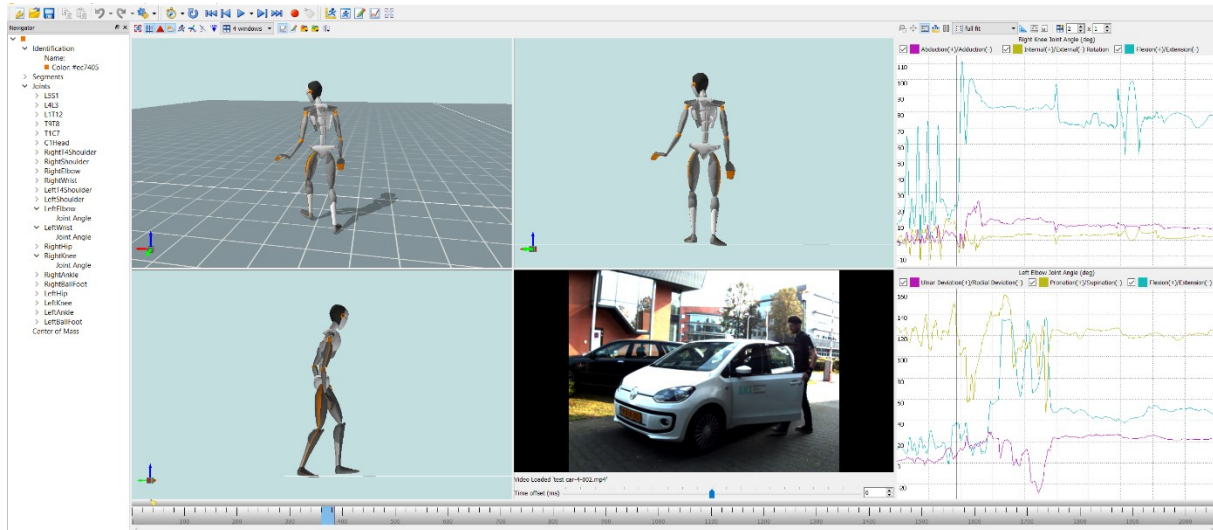

Figure 36: MVN Analyze/Animate interface

The main tool bar at the top of the MVN Analyze/Animate interface is displayed in Figure 37 below. Using this toolbar, much of the functionality of MVN Analyze/Animate can be called.

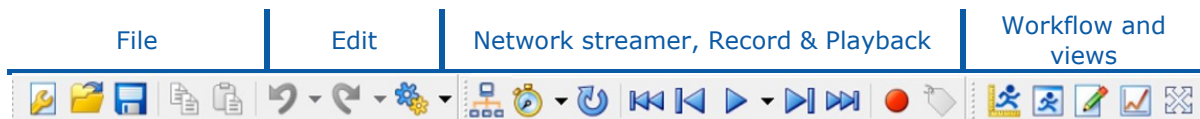

Figure 37: Main toolbar in MVN Analyze/Animate

## 6.1 Status Bar

At the bottom of the MVN Analyze/Animate interface is the status bar. It is important to pay attention to the icons shown here, as they give important information about the status of the system.

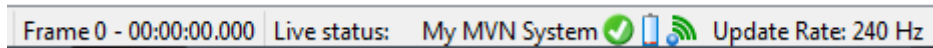

Figure 38: Example of Status Bar in MVN Analyze/Animate

- Frame number - Time
- Hardware status – status of wireless connection

Disabled	Searching	Ready

- Power – energy levels of batteries in for the Battery Pack or MTw's<sup>3</sup>

Empty				Full

- Radio – quality of wireless connection for the BP or MTw's<sup>4</sup>

Unknown	Bad	Moderate	Good

- Update Rate: 60Hz, 100Hz, 120Hz, 240Hz
- See Section 23.8 for more information about sample frequency versus update rates.
- Position aiding Hardware status

Good position quality	Acceptable position quality	Poor position quality	Fair position quality	No position data	Duplicate position data

## 6.2 Command line interface

MVN Analyze/Animate also has a command line interface to allow users to automate some of the processes.

- Command line options include Run, Reprocess, Export, Copy and Trim. For a full overview of the options: open a 'Command Prompt' in 'C:\Program Files\Xsens\Xsens MVN 20xx.x\MVN Studio' (Shift + RMB > 'open command window here').
- Run 'mvn\_studio64.exe -h' to get an overview of the available options

```

C:\Windows\system32\cmd.exe
C:\Program Files\Xsens\MVN Studio 4.3\MVN Studio>mvn_studio64.exe -h
C:\Program Files\Xsens\MVN Studio 4.3\MVN Studio>Usage:
mvn_studio64.exe --help
mvn_studio64.exe [<filename>]
mvn_studio64.exe <filename> [--reprocess]
mvn_studio64.exe <filename> [--reprocess] (-o|--output=<outputFileName> [(-t|--trim=<type>,<start>,<end>)] [-<customSetting>=<value>]*)
Examples:
Run the application and load input.mvn:
mvn_studio64.exe input.mvn
Reprocess input.mvn and output it to the same file:
mvn_studio64.exe input.mvn --reprocess
Export input.mvn to output.fbx:
mvn_studio64.exe input.mvn --output=output.fbx
Copy the first 3 seconds of input.mvn to output.mvn:
mvn_studio64.exe input.mvn --trim=reltime,00:00:00,00:00:03:00 --output=input.mvn
  
```

Figure 39: Command line interface

<sup>3</sup> Note that the battery indicators are also available in 'Hardware' pane. The animated battery in the status bar indicates the battery life of the MTw with the least amount of power.

<sup>4</sup> Note that the signal strength indicates that of the weakest wireless link to the connected MTw network.



## 7 Workflow and Functionalities in MVN Analyze/Animate

MVN Analyze/Animate is designed for optimal flow of the steps required for recording and analyzing motion. Different workflow items become active at various stages.



Figure 40: The workflow toolbar gives the user an optimal interface setup per functionality: Hardware and Fusion Setup, preview and record, playback and editing and analysis

### 7.1 New session

A new session is created during the workflow stage "Hardware and Fusion Setup". Before creating the new session, ensure that the hardware is connected and powered on.

#### 7.1.1 Create a New Recording Session

To create a new session, click the icon or go to File > Create a new recording session. Figure 41 shows the first interface to appear.

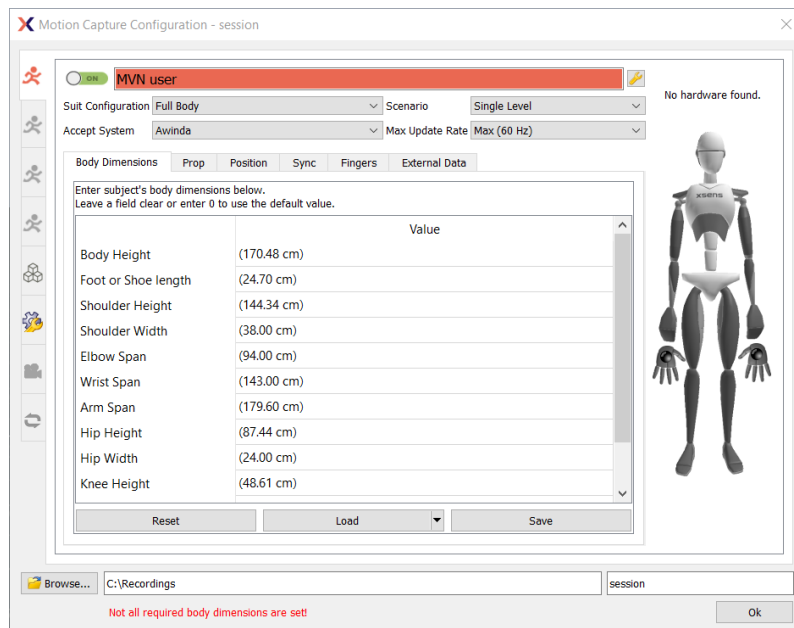

Figure 41: Configure a new session

Note that all details are default and ready for first time use. For quick start, wait for the status indicators on the avatar to turn green, click 'Ok'. Now the live, uncalibrated character will appear on screen. Go to Section 8 for instructions to proceed.

For a more informed, step-wise approach, it is useful to watch the tutorial or read the following steps for guidance below.

The Configure Session window shows 4 possible MVN Systems that can be connected to, systems, see 7.2 for more detailed explanation. On top of that, the Stealth mode can be enabled or disabled in the General Settings tab, see 7.3. The two bottom tabs are to configure the Video Camera (see 7.4) and the Sync Station (see 7.5). The connected

hardware can be configured in the Hardware Status panel (see 7.6) and the Navigator panel is described in 7.7. Tutorial video about setting up a recording session: <https://tutorial.xsens.com/video/set-up-a-recording-session>

## 7.2 Configure an MVN System

For each of the four possible MVN Systems, the user can configure the individual settings. Note that the Sync Settings dialogue is available only with an MVN Analyze license.

### 7.2.1 Enable/disable search for new system

 As described above, click the button on the top left corner from OFF (red) to ON (green). While the default settings are enough to proceed with a single suit, additional changes can be made.

### 7.2.2 System Status

 The system status can be monitored by checking the indicators on the avatar. Hardware status pane can be opened by clicking on the 'tool' icon. In accordance with traffic-light indicators, green indicates that everything is in order, while red indicates that there is a problem to be addressed. In the expanded view, the text accompanying the colored icon specifies the problem and clicking the spanner opens the hardware status window for detailed trouble shooting.

### 7.2.3 System Name

It is advised to change the name of the system from "MVN System 1/2/3/4" to a more personalized name, for example the name or ID of the person wearing the system. (It can also be deleted if not needed.)

### 7.2.4 View Hardware Status

 For MVN Link this view is only needed for troubleshooting or relocating trackers. For MVN Awinda, it may be necessary to change the radio channel, which is possible in the hardware status window. See Section 7.6 for detailed information.

### 7.2.5 Suit Configuration

When a connection between the PC and the live system is made, a detection phase takes place within MVN Analyze/Animate to detect all necessary hardware. To ensure that MVN Analyze/Animate searches for the correct hardware, ensure that the correct suit configuration is chosen. If for example full body is selected, when no hands are connected, this will result in an error when the suit is detected. There are multiple suit configurations possible in MVN. The suit configurations, sensors required for each for each are given in the table below:

Suit Configuration	Picture (green = active sensors, blue = inactive sensors)	Number of Sensors	Max Update rate – MVN Awinda (Hz)	Max Update rate – MVN Link (Hz)
Full Body		17	60	240
Full Body no hands		15	60	240
Lower Body		7	100	240
Upper Body		11	60	240
Upper Body no Hands		9	100	240
Lower Body with Sternum		8	100	240

## 7.2.6 Scenario

Depending on the type of measurement you will carry out, select the type of scenario that will ensure the best results, and minimize post-processing. The scenarios available include:

Scenario	Description
Single Level	This scenario assumes that the subject will be walking on level terrain
Multi Level	This scenario assumes that the subject will be walking on terrain or varying height, e.g. climbing stairs.
No Level	This scenario assumes that the subject will remain in a seated position, e.g. in a car. This means that the pelvis will remain at a preset height.
Soft Floor	This scenario is used if it can be assumed that the feet will slightly decrease in height, during the time between the feet contacting the ground and leaving it, e.g. grass, or soft carpet.
Vehicle	It is now possible to select a vehicle scenario for your data collection sessions. The vehicle scenario is very similar to the No Level scenario with an adjustment to the acceleration divergence monitoring. Meaning it can cope better with long and slow accelerations, such as when turning a gradual banking in a car. To select this scenario, when configuring your motion capture session, simply select vehicle in the Scenario tab.

## 7.2.7 Accept Systems

From this drop-down menu, select the type of hardware connected to MVN Analyze/Animate. This is set to "Any" as default, making it easy if only one system is connected. It is also possible to specify MVN Link or MVN Awinda.

## 7.2.8 Max Update Rate

From this drop-down menu, select the update rate for the systems.

**Note: MVN Awinda (starter) full body max update rate is 60Hz, MVN Awinda (starter) lower body max update rate is 100Hz and MVN Link full body max update rate is 240Hz**

## 7.2.9 Body Dimensions

	Value
<b>Body Height</b>	<b>(170.48 cm)</b>
Foot or Shoe length	(24.70 cm) <small>Ground to top of head when standing upright</small>
Shoulder Height	(144.34 cm)
Shoulder Width	(38.00 cm)
Elbow Span	(94.00 cm)
Wrist Span	(143.00 cm)
Arm Span	(179.60 cm)
Hip Height	(87.44 cm)
Hip Width	(24.00 cm)
Knee Height	(48.61 cm)
Ankle Height	(8.00 cm)
Extra Shoe Sole Thickness	(0.00 cm)

Figure 42: Input body Dimensions of test subject.

Figure 42 shows the interface for inputting the subject dimensions prior to a sensor to segment calibration. It is necessary to input Body Height and Foot length (shoe length at

the time of the measurement) in order for MVN Analyze/Animate to calculate other segment lengths (based on an anthropometric model).

**Note: A recording cannot be performed if the user does not insert these values; then the following error will be shown<sup>5</sup> (Figure 43).**

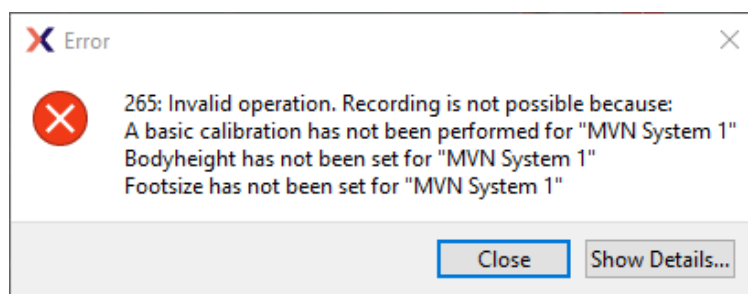

Figure 43: Error if recording attempted without subject height and foot length.

In addition to these basic measurements, other body segment dimensions can be adjusted for subject-specific anthropometry. The model-based values are presented between brackets, e.g. Knee Height "(48.61cm)". The scaling model is based on the height of the subject without shoes. The extra sole height can be added as an offset to the feet. The height of the ankle joint will be adjusted internally and other segment dimensions, such as the leg length, will not change. If the subject and ankle height are measured with shoes on, all segment lengths will be scaled based on this length and the shoe sole thickness should not be entered.

It is possible to provide values in either metric or imperial units. Metric units are active by default. To switch to imperial units go to: Options >Preferences >Interface >User interface >'Use imperial units (inches)'.

The specific body segment dimensions are presented in Figure 42. They can be found by palpating the anatomical landmarks, presented in the figures on the next page and in the online video tutorials: <https://tutorial.xsens.com/video/body-measurements>

Be careful! If you are not sure how to accurately measure the dimensions, do not change the default values; the calculated values are generally accurate enough.

To scale the model with these dimensions, click 'Apply'. The system will automatically update dimensions for which no user input is provided.

The subject body dimensions can be saved to your computer as an MVN Actor (.MVNA) file which then can be loaded the next time the same subject is used. After loading a subject file, it is still necessary to perform a segment calibration. It is also possible to modify body dimensions and reprocess the file with the new settings.

In order to facilitate data collections, body dimensions can be measured beforehand and input into MVN Analyze/Animate without connecting an MVN suit in the Session Configuration. This feature allows users to save body dimensions as an MVNA file prior to instrumenting a subject. Later, when the system is connected, the file can be loaded again from the Body Dimensions panel.

---

<sup>5</sup> Note that a recording can be performed without prior insertion of body dimension and without a calibration, if the feature "Allow uncalibrated recording" is enabled in the preferences menu.

Dimension	Description
Body Height	Ground to top of head when standing upright
Foot or Shoe length	Length of feet or length of shoes if wearing shoes
Shoulder Height	Ground to C7 spinal process
Shoulder Width	Right to left distal tip of acromion (acromial angle)
Elbow Span	Right to left olecranon in T-pose
Wrist Span	Right to left ulnar styloid in T-pose
Arm Span	Tip of right fingers to tip of left fingers in T-pose
Hip Height	Ground to most lateral bony prominence of greater trochanter
Hip Width	Right to left anterior superior iliac spine
Knee Height	Ground to lateral epicondyle on the femoral bone
Ankle Height	Ground to distal tip of lateral malleolus
Extra Shoe Sole Thickness	Additional thickness of soles, different from normal shoe sole height. Use for stilts, platform soles, etc. When this value is set, all other dimensions measured from the ground should NOT include this value.

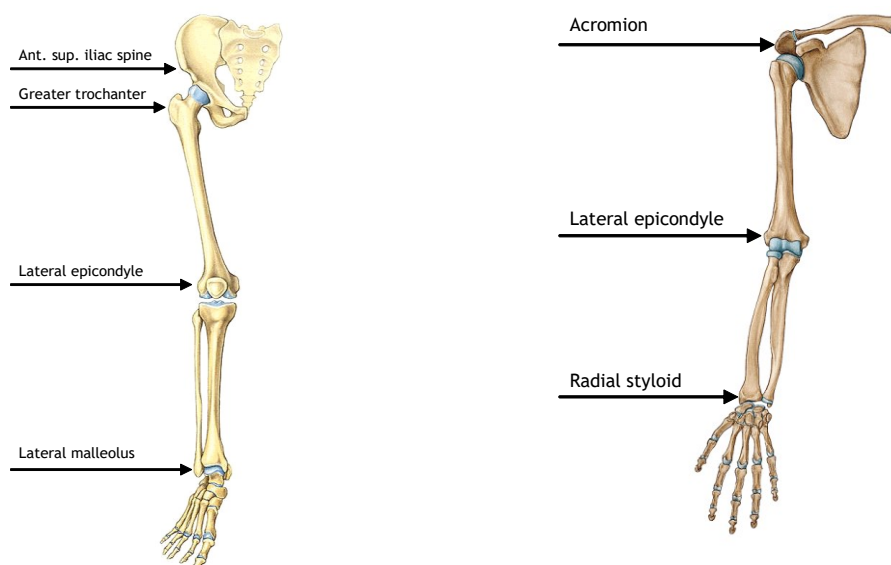

Figure 44: Anatomical landmarks on leg (left) and arm (right)

### 7.2.10 Props

In addition to the normal suit configuration, additional MT's can be attached to items to be measured in a recording, for example a sword, or a walking stick. These items to be measured are called "Props" and the motion tracker (MTw or MTx) attached to them are "Prop Trackers". A prop can be tracked by attaching a prop sensor to one of the free connectors on the hands.

The prop tracker must be configured in the new session dialog under 'prop' tab. Here, the type of prop can be selected (crutch, sword, gun, golf club, generic [this is simply a right-handed axis]), which can be assigned to a given suit and a given motion tracker ID.

Generally the motion tracker on the prop is detected automatically when clicking 'Apply' in the Prop Configuration window. If this does not occur, go to Tasks > Re-initialize suit(s). The prop mesh (the on-screen image of the prop sensor) can be connected to any defined point on a body segment. The prop can be rotated freely but will always follow the position of the selected point. By selecting the 'or' option, the prop tracker can be swapped between two segments, for example the right and left hand (see the example in Figure 45). MVN Analyze/Animate will automatically detect the side on which the motion tracker is connected.

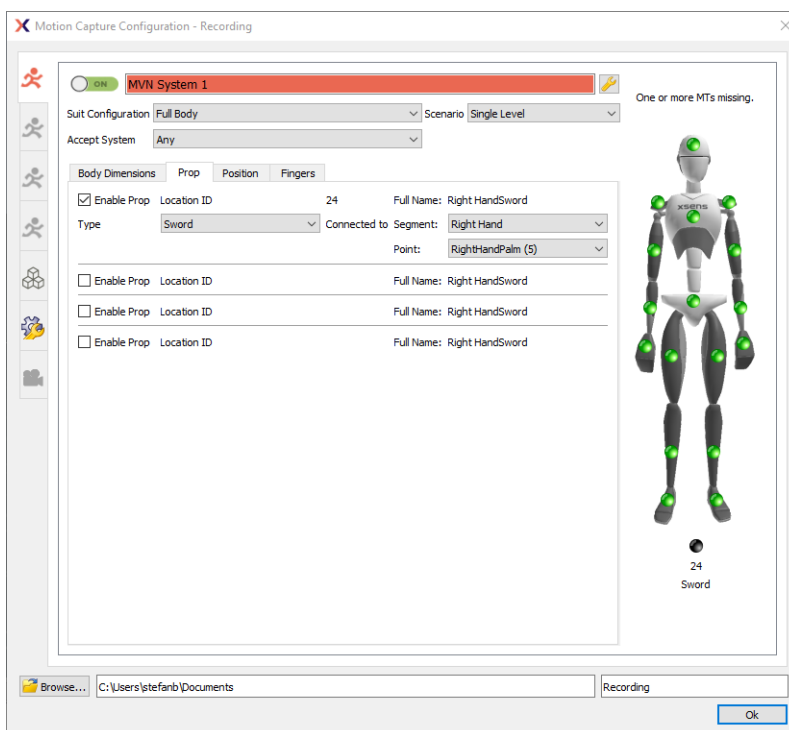

Figure 45: Prop configuration menu

The prop tracker should be mounted onto the prop such that two sides of the casing are parallel with the prop. For example, mount the prop tracker on the flat side of a sword with one axis aligned with the blade of the sword. Then, the orientation of the motion tracker can be set according to the natural orientation of the physical prop when holding it while in an N-pose. For more information, watch the tutorial for the MVN Awinda or MVN Link below.

Setting up props for MVN Link: <https://tutorial.xsens.com/video/setting-up-props-for-mvn-link>

Setting up props for MVN Awinda: <https://tutorial.xsens.com/video/setting-up-props-for-awinda>

### 7.2.11 Sync



With MVN Awinda, the dialogue to configure the sync settings is in the MVN System configuration. To configure the Sync Station which is the method for synchronizing MVN Link with third party devices, the sync settings are configured via the Sync Station tab, see 7.5 .

It is worth noting that sync with MVN Awinda is tighter than with MVN Link due to the tight control of the Awinda Station over the MVN Awinda System.

For detailed information regarding sync settings, refer to section 25.

## 7.3 General Settings

In the general settings tab, the user can enable the "Stealth Mode" option which disables all sounds and LED's on the body pack.

## 7.4 Configuring the Video Camera

If a video camera is to be used, enable the "Video Camera" in the respective tab. Note that before this can be configured, The MVN reference camera, must be plugged into the mains power supply and to the network connector of the pc or laptop in use. MVN Analyze/Animate should automatically detect the camera (if not, use the command "Scan for cameras"). If using a MVN Link system, connect the camera Ethernet cable into the Access Point and connect the AP directly to the Computer via Ethernet. Or choose the MVN Remote camera under source.

### 7.4.1 Configuration

Changing the video configuration is effectively changing the frame rate.

MVN Analyze/Animate supports VGA, video data will always be in color, with a resolution of 640 x 480.

To avoid flickering due to artificial lighting related to the mains frequency (50 Hz in Europe, 60 Hz in USA), select the appropriate frame rate (25 or 50 fps for Europe or 30 or 60 fps for USA).

Note that unless using a high performance computer with a fast HDD, it is advised that a lower frame rate is chosen (25 or 30 fps).



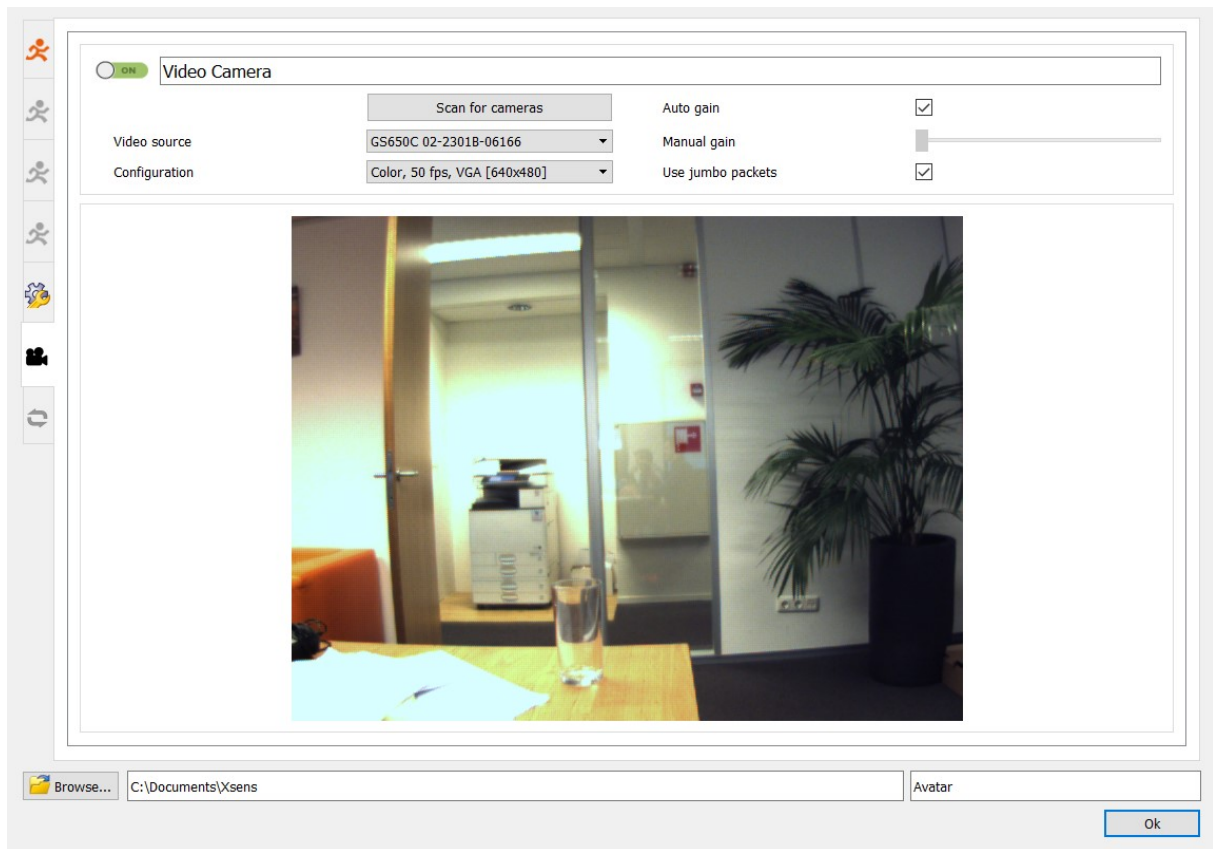

Figure 46: Example of camera configuration window

If no picture is displayed, if the image is jagged, or no camera is found, install the dedicated driver, found in C:\Program Files\Allied Vision Technologies. You may have to restart MVN Analyze/Animate for the camera to be found after this is installed. If no video data is displayed, check or uncheck the Use jumbo packets option to resolve the issue. The camera needs to be connected to the dedicated ethernet port on the pc, whereas the internet connection can use the USB to Ethernet adapter.

You may select to check the Auto Gain box or manually adjust the gain of the video yourself in this window.

## 7.5 Configuring the Awinda Station (or Sync Station)

The Awinda Station as part of the MVN Awinda setup can also be used for synchronizing between MVN Link and third party systems. The user will note that when MVN Link is selected, the text beside Sync Settings states "Not sync capable". The Awinda Station (or Sync Station) must be inserted for synchronization with MVN Link (Figure 47).

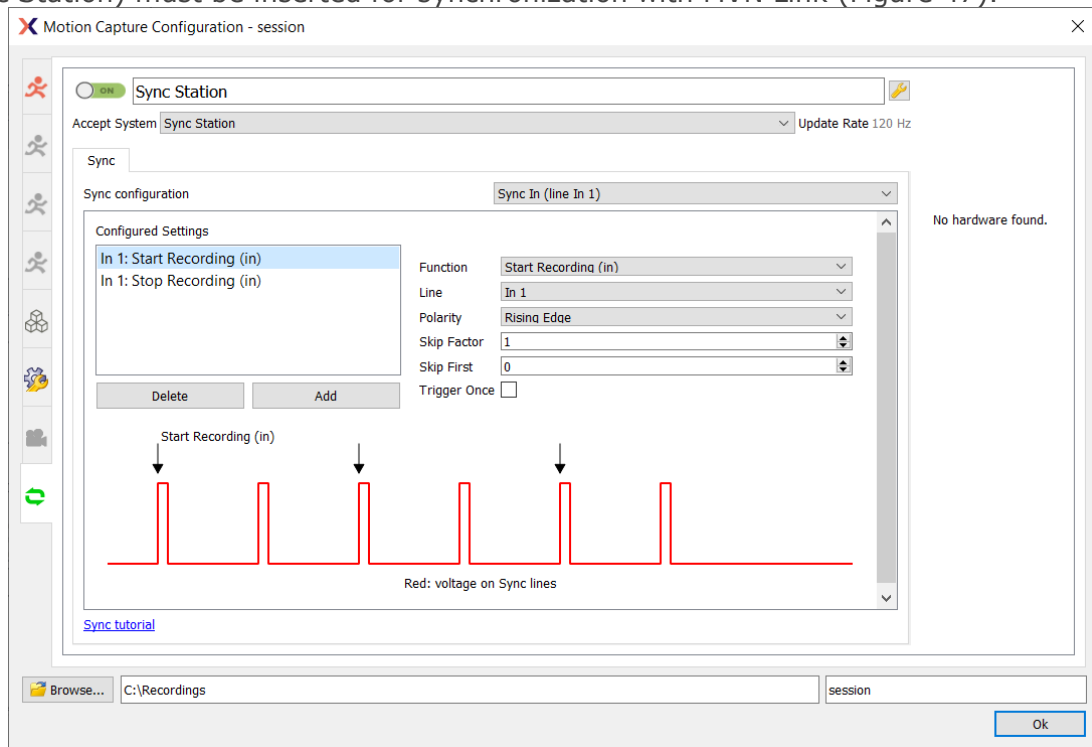



Figure 47: Sync settings

Click  to configure the sync settings. For details about each setting, refer to Section 25.

## 7.6 Hardware Status

To view the Hardware Status, Select the  in the configuration window.

Hardware status shows a list of all trackers and masters detected by MVN Analyze/Animate. The figures below show the hardware status interface and Table 1 details the meaning of the colored markers. This menu can be edited while the Configure Session window is also open, instructions for editing can be found below. When the Configure Session is not open, this interface is read-only.

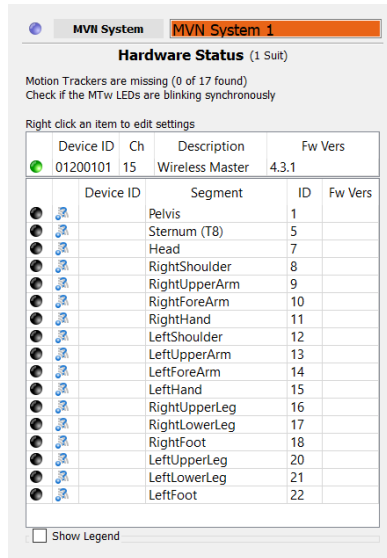

Figure 48 Hardware Status before a wireless connection has been established

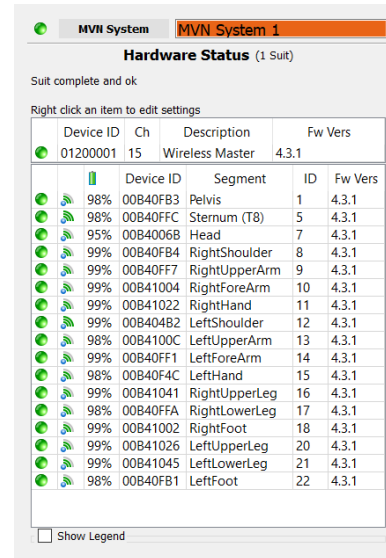









Figure 49 Hardware Status network connection is established and ready to measure

**Table 1: Legend of colored markers in detected hardware screen**

Icon	Legend message	Description
	Not detected	Motion tracker of a given segment is not detected
	Tracker Rejected	When a tracker is double click, indicating it is not needed, it is known as "rejected". Its icon becomes grey.
	Tracker Connected (MTw)	Motion tracker is connected to the master
	Master detected Network not locked	Wireless master is detected. Red icon has not been double clicked to secure the network.
	Connected (Master)	Green icon at the master indicates network is secured.
	MT unused	An extra motion tracker has been detected
	Duplicate	More than one motion tracker has been detected with the same location ID.

When all trackers have been detected, it may take some time (up to 30 seconds) to secure the network and for the 3D character to appear. Additionally, it may take several seconds for the battery status to display, please be patient to allow the information from each tracker to be transmitted to MVN Analyze/Animate.

### 7.6.1 Relocating motion trackers

Each Xsens motion tracker has a unique location ID which relates them to the limb segment they should be placed on. If for some reason, a tracker has the wrong ID assigned to it, e.g. if an additional motion tracker is detected or a broken MT needs to be replaced with a spare, this can be done easily by reassigning the MT's ID to the desired position.

To assign a tracker to a different segment, drag and drop the ID to the Location, or vice versa. Alternatively, right click in the correct row and select "Update location to". To ensure that the changes are saved, go to >Tasks >Reinitialize suit(s).

Note that if two motion trackers are accidentally exchanged, for example on the hands or feet, do not use this function but reconnect the MT's to the appropriate side and wait for the hardware status to update.

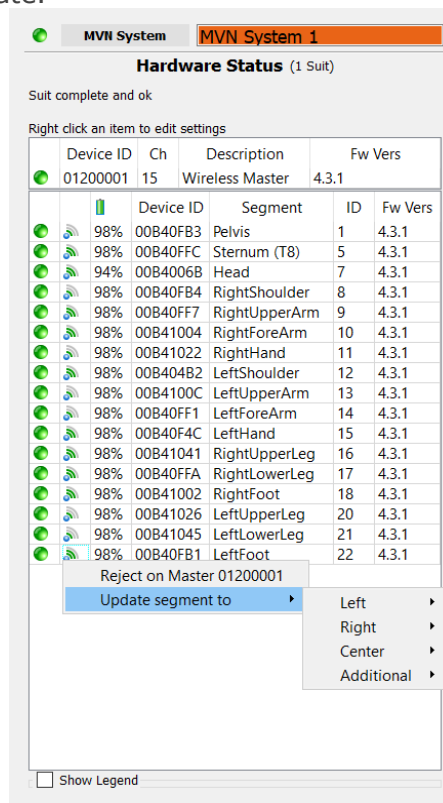





Figure 50 Relocating trackers

### 7.6.2 MVN Awinda: Changing Radio Channel

	<p>For MVN Awinda users, the Hardware Status is necessary in order to configure the network detection status of the system.</p> <p>Figure 48 Shows a list of motion trackers expected to be found by the MVN Awinda system. The icons of these trackers are black indicating that they are expected but not yet detected. As the Awinda Station is searching for MTw's, the CONN LED of the Awinda Station, or the white LED of the Awinda USB dongle blinks rapidly. As each MTw connects, its LED will blink synchronously with that of the Awinda Station and its indicator will turn green in the Hardware Status window, see Figure 49.</p> <p>When the trackers has been detected, the status of the remaining battery power () and the wireless strength () of each tracker is available, see Figure 49 for an example.</p>
---	--

### 7.6.3 MVN Awinda: Changing Radio Channel

	<p>In the Hardware Status window, either right click or double click the number under the letters "Ch". A small menu appears providing the option to change radio channel, reject unused trackers or "forget" system.</p> <p>In general, when working in an environment known to have a lot of WiFi traffic, it is best to select channel 11, 15, 20 or 25. See Section 23.11.1 for background information.</p>
---	---

### 7.6.4 MVN Awinda: Reject Unused Trackers

	<p>Again, in the Hardware Status window, either right click or double click the number under the letters "Ch".</p> <p>From the small menu it is possible to reject unused trackers. It is possible that the MTw is powered on, but not needed for a particular session. This is particularly useful for owners of multiple Awinda Systems where an MTw is detected by one Awinda Station but is needed at another. To remove detected trackers, either select the "reject unused trackers" or double click anywhere on the row the tracker appears in and select "Reject on Master *****". If this was done accidentally of you want to accept a new tracker, simply double click again and select "Accept on Master *****".</p>
---	--

### 7.6.5 MVN Awinda: Forget System

To explain the use of the command forget system it is first useful to understand how MVN Analyze/Animate deals with connection. For single person capture, the information in the hardware status window tends to always be the same tracker/master information. However it may change depending on: different suit configurations and whether or not props are used. Additionally, some institutes may have multiple suits within radio contact of each other, each measuring one subject. For this latter usage and for the purpose of multi-person capture (multiple suits connecting to one MVN Analyze/Animate instance), MVN Analyze/Animate actively remembers which motion trackers have connected to which master (Awinda Station or Body Pack). The result is that when the user attempts to connect the trackers to the same master at a later time, MVN Analyze/Animate only allows the remembered trackers to connect. This ensures efficient connections for always using the same suit configuration and prevents unwanted connections between masters and trackers.



Again, in the Hardware Status window, either right click or double click the number under the letters "Ch".

If a user attempts to make a connection in an existing configuration between an Awinda Station and a tracker used for the first time the option "Forget System" should first be selected. After this command, all trackers (including previously rejected ones) can connect again.

When all devices necessary for the suit configuration are detected, the 3D character will appear in the 3D viewport.

Ensure that the filename and directory are correct; then click apply to proceed. See section 8.

## 7.7 Navigator

When a new session has been created, suit-specific variables can be viewed in the navigator. This generally appears automatically on the left side of the window. If not, it can be found using View > Navigator. In the navigator, parameters of the suit can be seen, including the Suit ID and the color of the indicator above the head of the 3D character. While this is possible with only one system, it becomes essential when multiple systems are being recorded at once.

If recording of multiple suits has been chosen during the new recording session, MVN Analyze/Animate will search for the selected number of systems. If more than one system is connected, the hardware status will have additional tabs to reflect this.

## 8 Setup

The setup workflow stage consists of three parts; it shows the subject's body dimensions (see 7.2.9), data fusion and sensor to segment calibration. The calibration procedures are only available once the MVN system is connected and the 3D Character has appeared in the view port.

When a file has been recorded this icon remains active to enable changes to body dimension inputs.

**Note: It is not possible to save a calibration file, when a recorded file is open.**

The following steps are described for single system calibration. If multi-person capture is enabled, each step should be repeated for each additional system.

### 8.1 Calibration

Segment calibration is the step required to align the motion trackers to the segments of the subject. Creating a good calibration is of utmost importance in order to ensure accurate results. For this reason, the calibration procedure should be carried out with care to get the best performance.

Watch the video on the tutorial portal for instructions on how to perform the calibrations:  
Calibration for MVN Awinda: <https://tutorial.xsens.com/video/calibrating-awinda>  
Calibration for MVN Link: <https://tutorial.xsens.com/video/calibrating-link>

#### 8.1.1 Record and process calibration

- Select a calibration (Npose + Walk or Tpose + Walk).
- A new image will appear in the 3D viewport which should be replicated by the subject.
- If the subject is alone, first select "Hands off calibration" and the amount of time needed to get into position. (See Section 8.1.3)
- Click "Calibrate".
- Ensure that the subject is holding the initial pose.
- Click start and follow the instruction to stand in the static pose, relax and walk back and forth.
- Once the calibration recording is finished, the system will automatically start processing the recording to get the results and show the progress.

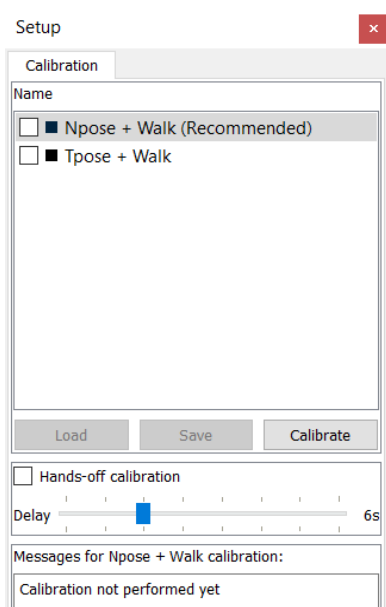

Figure 51: Segment calibration interface

### 8.1.2 Apply calibration and define x-axis

When the calibration data has been processed, the system will show the quality of estimated calibration parameters and show warnings in case problems were detected (see Section 8.1.4 for more information).

Before applying the calibration results, the forward pointing X-axis can be defined. To do so, the user is asked to stand in N-pose facing the forward axis of the measurement environment. In a setup with multiple MVN systems, each actor needs to perform this alignment. In this case, it is recommended to mark a place on the floor indicating the origin of the session. Each person should stand on this spot **with the right heel** when applying the calibration.

The MVN system does not have an absolute positioning system. Therefore, the characters will show some drift over time in terms of absolute position in space with respect to the origin (defined at calibration). For short recordings, the drift of the character is typically limited to a few cm. With multi-person capture, the characters can drift apart after a while. Usually this can be fixed in the animation package used for retargeting the motion data to a virtual character.

To reset the position and/or orientation of the characters in between recordings, select the character in the navigator and perform the required reset:

- Reset position (menu > Tasks > 'Move Character to Origin' , or press 'Ctrl-0' (Ctrl+[Zero Key])).
- Reset heading (menu > Tasks > 'Axis Reset' , or press 'Ctrl+Alt+A').
- Reset position + heading (menu > Tasks > 'Grid Reset' , or press 'Ctrl+Alt+G').
- Reset mocap engine (menu > Tasks > 'Reinitialize Mocap Engine' , or press 'Ctrl+Alt+F').

Please note that this step means all history in the engine is thrown away and the engine will start from scratch.



Please note that it is always recommended that a calibration is performed before beginning to record data using MVN Analyze/Animate. However, it is possible to enable a measurement without calibration in the preferences menu (Options >Preferences >General >Recordings).

Another option in the preferences menu is "Enable simple calibration routines" in this menu to enable the not recommended N and T-pose. Please note that these calibrations are susceptible to magnetic distortions and can have a degrading effect on the preserved performance.

### 8.1.3 Hands-off calibration

It is possible to perform a calibration without assistance. Click the 'Hands-off calibration' check box and select the delay time. This is the time needed between clicking 'Start' and getting into position. Continue the calibration by clicking the 'Calibrate' button. Following the preset time delay, the calibration recording will automatically begin.

### 8.1.4 Calibration quality

MVN Analyze/Animate will perform several checks to determine the quality of the calibration routine. These checks include: a measure for standing still, the expected alignments of the MT's on specific segments, and the detection of the walking part.

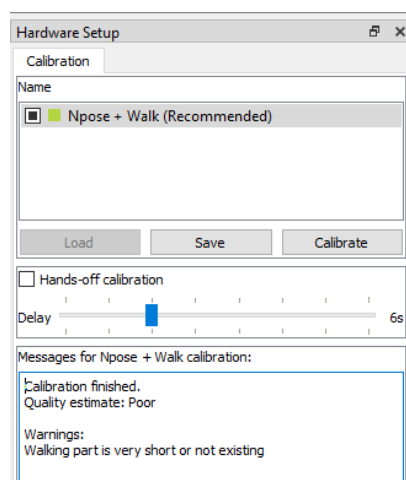

Figure 52: Example of result of calibration quality

There are four levels of calibration quality:

- good
- acceptable
- poor
- fail

Generally, a 'good' or 'acceptable' quality indication is sufficient. If the calibration result is not 'good', the reason is indicated in the text below. Read the advice provided to improve the result. If the result is "acceptable", consider repeating.

A 'poor' quality indicates the engine was not able to properly extract the calibration parameters and will give feedback what went wrong. It is still possible to continue with recording, but it is better to repeat – taking into account the advice provided.

Note that a 'good' or 'acceptable' quality indication does not necessarily mean that the actual calibration is accurate. MVN Analyze/Animate can perform limited checks of the actual pose of the subject during the calibration due to a natural variation in body physique and locations of the motion trackers on the body. Therefore, always pay attention to the pose of the subject since it will influence the quality of the recording.

Calibration data can be saved. This is useful if MVN Analyze/Animate closes/must be closed suddenly. When rebooting, data can be reloaded, without having to re-calibrate. To reload a calibration (including body dimensions), click 'Load'.

## 9 Preview and Recording

### 9.1 Preview

During the Preview and Recording stage of the workflow, the viewport is active.



There are a number of viewing possibilities, the 3D character in the 3D viewport and orthogonal views. Select the number of windows to view at one time. Figure 53 is an example of a four window view showing the 3D view and three different orthogonal views. To select which type to view, Right Click and select from the drop down menu, as indicated in the figure (or use the shortcut keys). The view changes only in the window where the cursor is pointing. In the 3D viewport, use the mouse to zoom (using scroll wheel) and pan (using middle mouse button) around the character. It can be viewed from any angle (change view using left mouse button) and distance.

With MVN Analyze it is also possible to have the synchronized (live) video data. If video is enabled it automatically uses a window. Note: there is a difference between the virtual camera and the physical MVN Ethernet Camera. The camera views describe the possible viewing angles of the 3D character. The only preferences for the MVN Ethernet camera are in Options >Video Camera Settings.

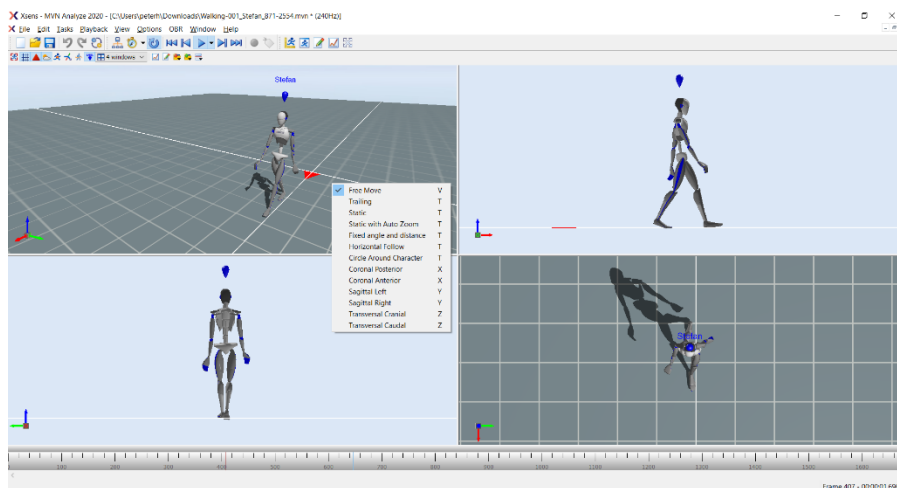















Figure 53: Example of 4 window view on the 3D view port. Top left is the 3D view. Bottom left is sagittal right. Bottom right is transversal cranial. Top right is coronal posterior.

### 9.1.1 Viewport Icons

The icons above the viewport can be selected to show and hide various parameters, as detailed below.

Icon	Task
	Focus on Selected Segments (short-key 'F') Note: short-key 'C' always centers on the pelvis
	Show/hide floor
	Show/hide origin
	Show/hide shadows
	Show/hide center of mass
	Show/hide biomechanical model
	Show/hide motion path (available during playback)
	Show/hide character label
	Amount and layout of viewports
	Show/hide graphs
	Enable/disable contact editing in current view
	Save Layout
	Restore Layout
	Select between a vertical or horizontal layout

### 9.1.2 Views

Right click on the screen (or use the shortcut key) to choose one of the following camera viewpoints:

Menu command (+shortcut)	Action
Free move (V)	The camera is still. The character may go out of view of the screen.
Trailing (T)	The character is always in view. The pitch of the camera is fixed. The distance of the camera to the character is fixed. The height of the camera follows the height of the pelvis. The camera heading is determined from the previous and new character position.
Static (T)	The position of the camera is fixed. The camera always looks at the character.
Static with Auto Zoom (T)	Similar principle to "Static" with the addition that the zoom is automatically adjusted to ensure that the character remains the same size

Fixed angle and distance (T)	The global heading and pitch of the camera are fixed. The height of the camera follows the height of the pelvis.
Horizontal Follow (T)	Similar to "Trailing", but the height and angle of the camera is now adjusted to prevent the image from varying with change in pelvis height
Circle Around Character (T)	Virtual camera will slowly circle around the centered character
Coronal posterior (X)	Show the back of the character.
Coronal anterior (X)	Show the front of the character
Sagittal right (Y)	Show the right side of the MVN character in the sagittal plane
Sagittal left (Y)	Show the left side of the MVN character in the sagittal plane
Transversal cranial (Z)	Show the top of the MVN character
Transversal caudal (Z)	Show the bottom of the MVN character

The camera angle of the orthogonal views is by default defined by the movement of the pelvis. The height of the camera is also based on the pelvis; when the character is jumping the character stays within the view while the floor appears to move. This also has implications in the sagittal view; the subject may bend, while this appears as though the feet slide forward. The data is still correct (as seen in the 3D view).

### 9.1.3 Real-time graphs

With an MVN Analyze license it is possible to view graphical representation of data even in real-time and during recording.

To do this, click the graph icon, and as with offline graphs, click and drag items from the Navigator.

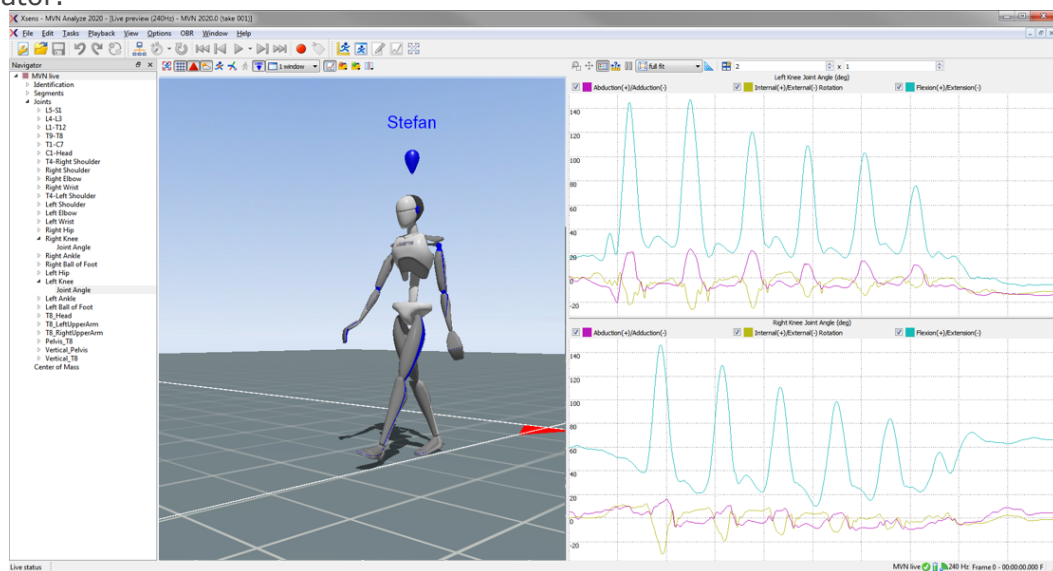

Figure 54: Real-time graphs

Figure 54 is a screenshot of MVN Analyze/Animate with real-time graphs present. The key difference with this and the offline graphs is the lack of time bar.

The real-time graphs have the same functionality as offline, for more information on graphs, see Section 14.1.

Note that it is possible to zoom on the vertical axis. First ensure that "no auto-scaling is selected from the drop down menu, and then select the magnifying glass icon to zoom. However given that it is not possible to select a time window over which to observe the

real-time graphical data, the recommended setting during real-time preview is “Expand to fit”, or “Full Fit”.

#### 9.1.4 Save and Restore Layout

To the right of the graph icon are two icons indicating the possibility to save and restore layouts of the interface.

To save a layout, use the icon directly to the right of the graph icon, the layout currently in view will be saved. Give the layout a name, in the drop down menu that appears.

To use a saved layout, click the rightmost icon “Restore Layout” and select the name from the drop down menu that appears.

It is possible to delete a given layout by selecting it and clicking the delete button on the keyboard.

## 9.2 Recording

To record, save and export data, first make a new session (as described above) and perform a calibration.



Press the red record button to start a trial recording. Press the same button to stop recording. The short key for starting and stopping recording is ‘Ctrl+R’. All recorded and saved files will have the name of the session, appended with a trial number (e.g. session = ‘running\_take’ will result in trial recordings ‘running\_take-001.mvn’, ‘running\_take-002.mvn’ etc.). When a recording has been made, the recorded file automatically opens. This can be disabled in Options >Preferences >General >Recordings >Automatically open MVN file after record ends.

#### 9.2.1 Note for recording for MVN Awinda Users



When a recording is initialized in MVN Analyze/Animate for MVN Awinda, the “Data” LED of the Awinda Station becomes red, to indicate recording is in progress. Note that if data packets have been missed, retransmission slots ensure that the Awinda Station can recall these and they can be retransmitted during recording (retransmissions are activated only during recording).

When recording is stopped, the “Data” LED may become temporarily orange, and the record button in MVN Analyze/Animate will temporarily appear as if the recording is paused, the missed data packs are being flushed.

When opening a recorded file with flushed data it will automatically start reprocessing. This will ensure that the file contains all data, including retransmitted data from during the recording and data that was flushed from the buffer of the MTw2 at the end of the

---

<sup>6</sup> With MVN Awinda this button will continue even for a few seconds after recording is stopped, at this time, any samples missed during real-time recording are being flushed to the PC.

recording. For this reason, the recorded data is often of better quality than the real-time preview.

### 9.3 Add comments after recording

Adding comments after a recording has finished can be very useful in a later stage when you are opening the recordings. The popup dialog to add comments after a recording can be enabled or disabled (menu > Preferences > Interface > User Interface Show popup dialog for file comments after recording).

To view the comments from the open file dialog in MVN Analyze/Animate or Windows Explorer, you will have to add the 'comments' column. Right click on the column header and click on 'more', now you can check the 'comments' column.

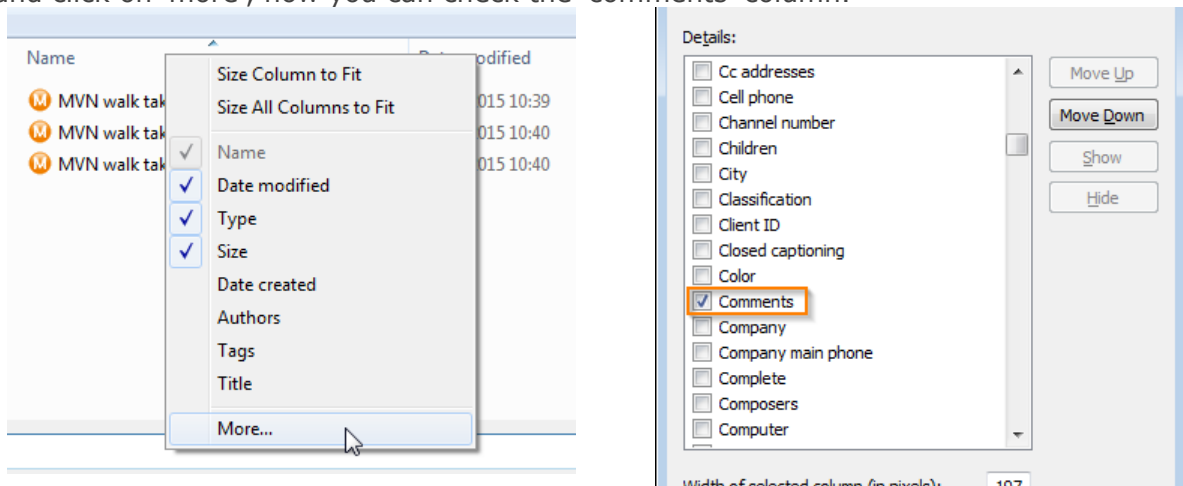

Now when you are looking for that recording that was 'perfect' you will be able to easily find it from either the open file dialog in MVN Analyze/Animate or Window Explorer. When the comment contains a lot of text and is not fully visible you can hover over the text and a tooltip will display the complete text.

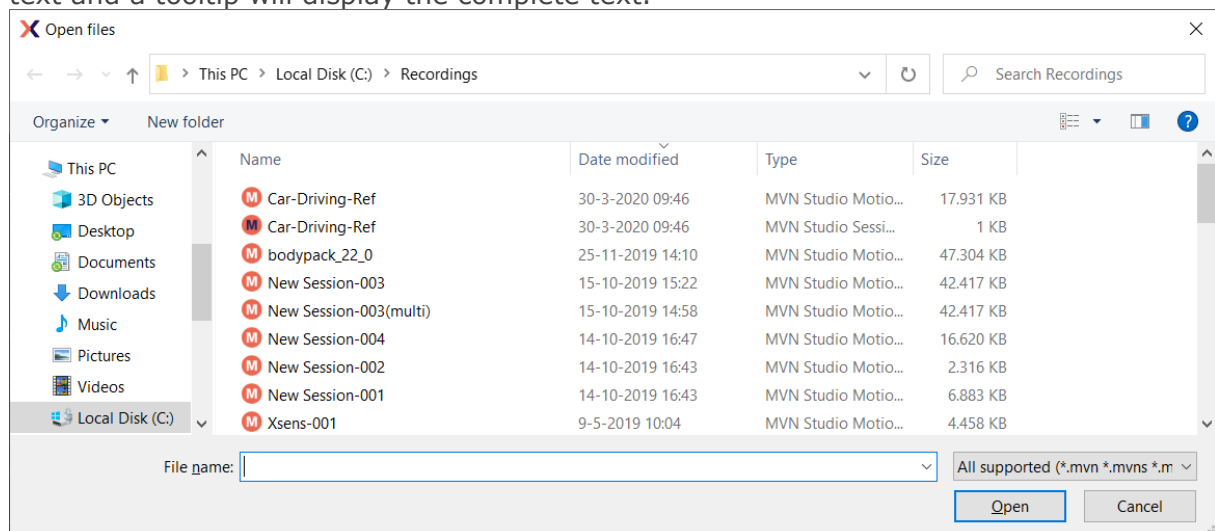

Figure 55: Open files

The comments in recordings can be edited in MVN Analyze/Animate from the Comments pane (menu > View > Comments).

## 9.4 Recovery of MVN file after system crash

If MVN Analyze/Animate was shut-down as a result of a system crash, the MVN file will not be properly closed and not useable. To correct this, when you try to load the corrupted MVN file in MVN Analyze/Animate it will look for a recovery file (MVR) that can be used to recover the data captured. A message will ask if you want to use a recovery file. This file has the same name and location as the corresponding MVN file but with a "MVR" extension. The file is used by MVN Analyze/Animate to recover the corrupted MVN file.

## 9.5 Markers

During or after recording, markers can be added to the timeline to indicate events. During recording, add a marker by clicking the Add Marker icon or by using the '+' key or 'space bar'.



In the playback window, a marker can be added and/or edited by double-clicking the timeline at a specific frame or by using the '+' key. To add a marker directly, in the playback mode, double click on a time frame, to obtain the "Set Marker" menu shown in Figure 56. Alternatively, right click above the time frame, select "Add marker" and the same "Set Marker" menu will appear. Change the name of the marker in this menu to identify the marked event.

When the marker is set, it will become yellow. Markers can be deleted by pressing the delete button after selecting the marker, or selecting delete marker when right-clicking above the time line.

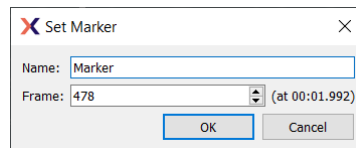

Figure 56: Set Marker Menu

Markers are saved as default to MVNX file. See Section 15.4.

To jump between markers, either go to Playback > Jump to next/ previous marker, or user the quick keys 'PgUp' for previous and 'PgDown' for next.

Note that when multi-person capture is used, the markers are saved in each MVN file. When the MVNS file is opened, it includes these MVN files. This means that there can be a discrepancy when two different sample rates are used eg if MVN Link and MVN Awinda are used. For this reason MVNS file may appear to contain multiple markers, since they have been allocated slightly different times. Each MVN file itself will still only contain one marker.



## 9.6 Network Streamer

The network streamer sends the poses of the active window (playback or real-time), both UDP and TCP are supported by the network streamer. The UDP Protocol is unidirectional, and contrary to TCP (Transmission Control Protocol, RFC 793) it is stateless and does not require the receiver to answer incoming packets. This allows greater speed.

How to set up the network streamer is explained in this tutorial video.  
<https://tutorial.xsens.com/video/setting-up-multiple-streams>

You can use a network monitor on another or same PC to receive this stream, or write your own receiver in another application.

Change network streaming settings in Options > Network Streamer.

To enable streaming, activate the 'Enable network streaming' checkbox. The receiving network address can be entered in 'Destination addresses'. Use 'localhost' to send/receive on the same computer. UDP is the default protocol.

It is possible to stream to multiple destination addresses.

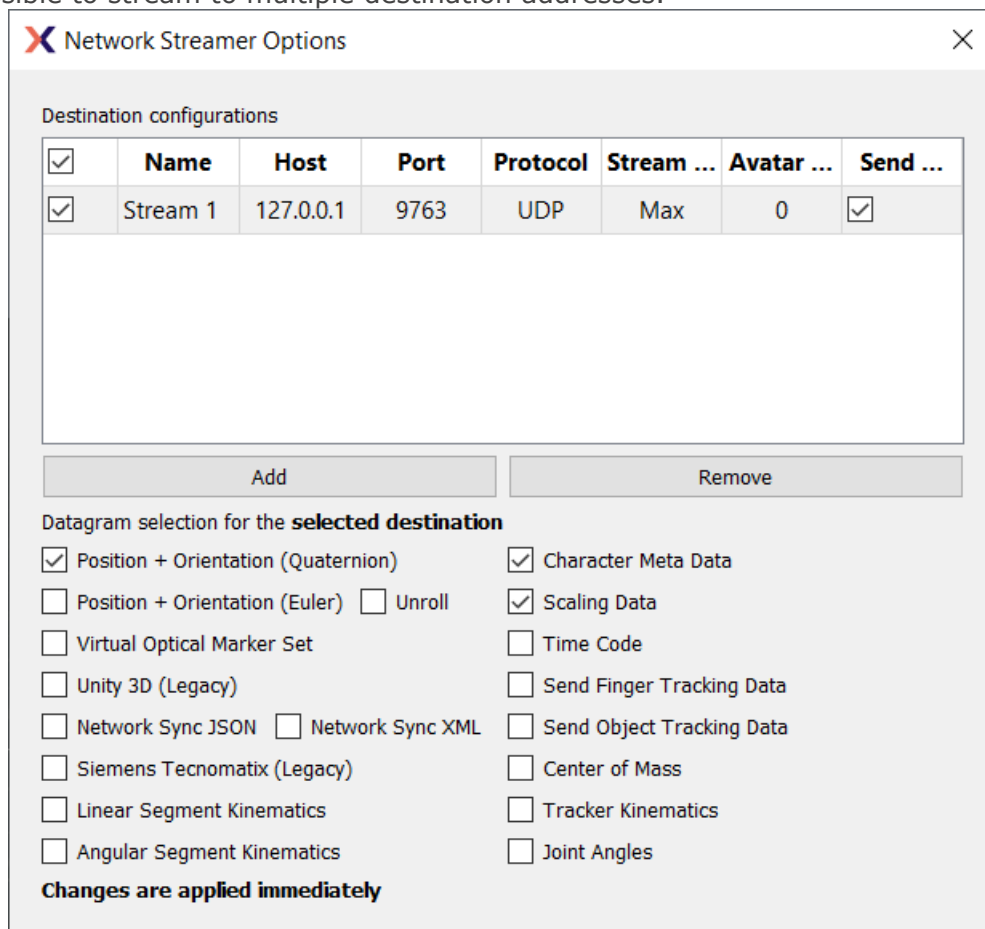

Figure 57: Network Streamer Options

Figure 57 above shows the Network Streamer Options. The table below summarizes the functionality of each selection. Please refer to the Real-Time Network Streaming Protocol Specification for further details.

Datagram	Description
Position + Orientation (Quaternion)	Positions and orientation of each body segment, orientations in quaternion format, position units are in meters. This is the most accurate and preferred format for new application development. Use this to stream from one MVN Analyze/Animate to another. Select the 'Scaling Data' for proper visualization of the character mesh.
Position + Orientation (Euler)	Position and orientation of each body segment. Orientations are Euler and position data is in meters. This is the format needed to send data to the MVN MotionBuilder (2018 and older) Live plug-in. See the MVN MotionBuilder plug-in user manual for further details.
Character Meta Data	Particularly useful when streaming data during multi-person capture, when selected, this protocol streams information inserted about the character including the character as inserted in the Navigator as well as the ID of the Body Pack or Awinda Station. This feature is supported by MVN Analyze/Animate as a network monitor.
Scaling data	This packet contains scaling information about the character, including the null pose definition and point definitions to scale a mesh.
Unity 3D	This setting should be selected in the network streamer for users of the Unity plugin. See the Unity plugin user manual for more details.
Siemens Tecnomatix	For MVN Analyze customers, it is possible to stream data in real-time to Siemens PLM software using this selection. See separate user manual for set up.
Linear Segment Kinematics	Absolute segment position, linear velocity and linear acceleration.
Angular Segment Kinematics	Absolute segment orientation, angular velocity and angular acceleration.
Virtual Optical Marker Set	This protocol streams a set of virtual optical markers. This is the virtual marker set for the 1.0 Motion Builder plug-in. This data is not supported for playback in MVN Analyze/Animate.
Center of Mass	Absolute 3D position of the center of mass.
Tracker Kinematics	Absolute 3D tracker orientation (quaternions) and free acceleration. Local acceleration, angular velocity and magnetic field of the sensor components. This feature is not supported by MVN Analyze/Animate as a network monitor.
Joint Angles	Data is contains point ID of the parent and child segment orientation and the joint angle in X,Y,Z.
Time Code	MVN Analyze/Animate contains a clock which starts running at the start of a recording. The clock measures the elapsed time in milliseconds. When data is sampled, the current value of the clock is also sampled and stored in the datagram(s) as a 32-bit unsigned integer value representing a time code. When this option is selected a string of this Time Code is streamed (HH:MM:SS.mmm).
Send Finger Tracking Data	This setting should be selected in the network streamer for users who want to include Finger tracking data.
Send Object Tracking Data	This setting should be selected in the network streamer for users who want to include Object tracking data.
Network Sync JSON/XML	For triggering other (3rd party) software, in different formats. Messages: <ul style="list-style-type: none"> <li>• session name + take number</li> <li>• file path where the recorded files are (to be) saved</li> <li>• start/stop recording</li> </ul>

## 9.7 Network Monitor

MVN Analyze/Animate also implements a Network Monitor that can receive the MVN network stream of motion data. Note that this is mean only to monitor a network stream and no further functionality is provided than viewing (i.e. no saving, recording, editing etc).

To open a network monitor in MVN Analyze/Animate, go to File >Open Network Monitor or press "Ctrl+M", to obtain the menu shown in Figure 58.

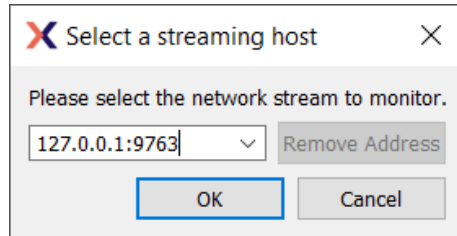

Figure 58: Select streaming host

Here, enter the IP address of the sending computer or use 'localhost' if sending and receiving on the same PC.

## 10 Playback, reprocessing and editing

When the data has been recorded, MVN Analyze/Animate offers several options for playback, reprocessing, video synchronization, and editing which will be discussed in this section.

### 10.1 Reprocess HD

With MVN Analyze/Animate, a new sophisticated processing option is available called "Reprocess HD", which includes all data in the file to get the best performance for the recorded motion. The reprocessing can be enabled by pressing 'Ctrl+Shift+P' or click the icon below.



When a MVN files is changed (e.g. changing scenario), it must be reprocessed to ensure that the changes are implemented. If the file is opened for the first time and contains retransmitted data, the file is automatically reprocessed to be sure all data is included in the engine ('Auto-reprocess'). In order to use the HD reprocessing, manual trigger of the reprocess HD is needed. Note that the default behavior of the icon can be changed from 'Auto-reprocess' to 'Reprocess HD' by clicking on the dropdown arrow to the right of the icon.

The progress of reprocessing can be monitored in the frames bar at the bottom of the viewport. Data will first be read into the engine (indicated by the blue color), and then be processed by the engine (light green). Once the file or part of file has been finished, it is shown in green as shown in Figure 59.

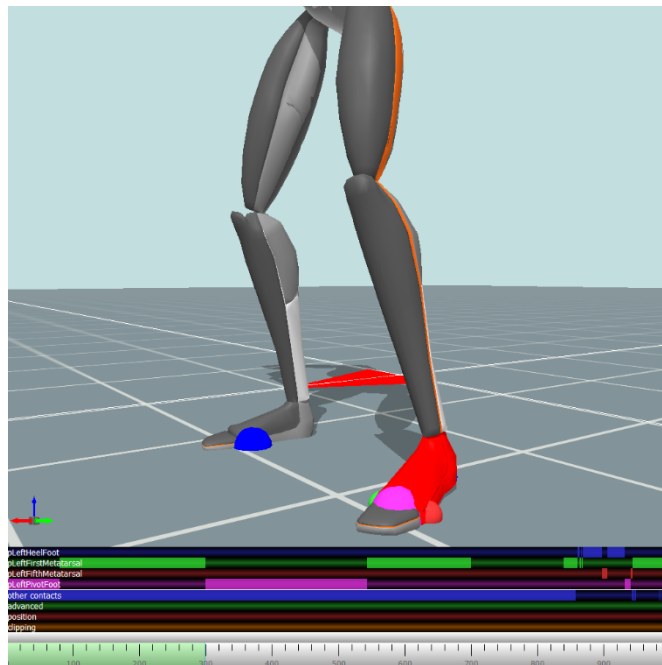

Figure 59: Contact editing reprocess bar

### 10.2 Batch Reprocess HD

The option to do batch processing is also possible in both normal and HD quality. This can be done from the tasks tab, using the *batch reprocess* option (Figure 60). Once this

window has opened, the input and output paths can be chosen with the level of *reprocessing* quality you desire. You can also change the number of *parallel processes* that are used during processing. This determines the amount of files that are reprocessed at the same time. Be advised that increasing this number will significantly increase the memory usage of MVN during reprocessing. The default setting should provide a sensible balance between CPU and memory usage.

*Force reprocessing* can be used to force reprocessing, even if files have been processed with the same reprocessing quality earlier (not recommended). *Use GNSS data* uses available position aiding data to improve reprocessing. GNSS data can only be used in combination with HD Quality reprocessing. It is recommended to leave both settings at their default values.

Clicking *Reprocess* starts the reprocessing and shows the progress per file in a separate window. The processing can be canceled at any time.

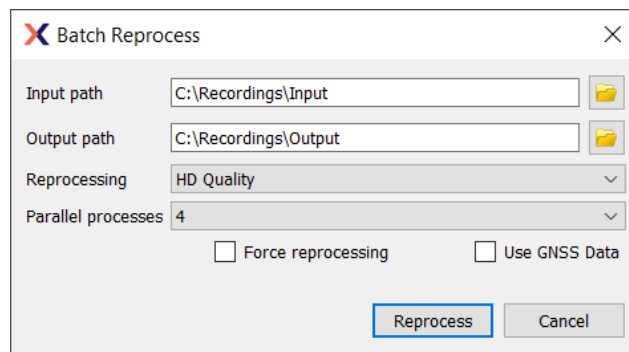



Figure 60: Batch Reprocess window

### 10.3 Playback

Playback becomes possible with a recorded trial. To play and edit recorded files, open an MVN, MVNS or MVNX file. The Playback Toolbar contains familiar playback options.

If multiple MVN, MVNS, or MVNX files are open, all files can be controlled at the same time using Global Playback options. When analyzing similar recordings, to make all files jump to the same frame, simply use the quick key 'Shift + Down'.

Icon	Task	Short Key	Global Playback Short Key
	Playback speed		
	Loop recorded data	R (toggle)	Shift + R
	Go to start	Home	Shift + Home
	Previous frame	Cursor left	Shift + Cursor left
	Play / Pause	Space bar	Shift + Space bar
	Play selection	Ctrl + Space bar	
	Next frame	Cursor right	Shift + Cursor right

	Go to end	End	Shift + End
---	-----------	-----	-------------

## 10.4 Synchronization with video

In MVN Animate Pro, MVN data with synchronized video is available. The accuracy of the software synchronization depends heavily on the LAN connection to the camera and the wireless link quality to the MVN system. In general, the time offset between the MVN frame and the video frame is negligible, or less than 1-2 video frames.

However, if there is a larger offset between the MVN and video data, time-synchronization can be manually corrected using the sliding bar under the video. Drag the bar or use the numbers or the arrows to change the offset [ms]. The offset is applied to the whole file. Any clock skew between the camera and the MVN system is automatically estimated and corrected.

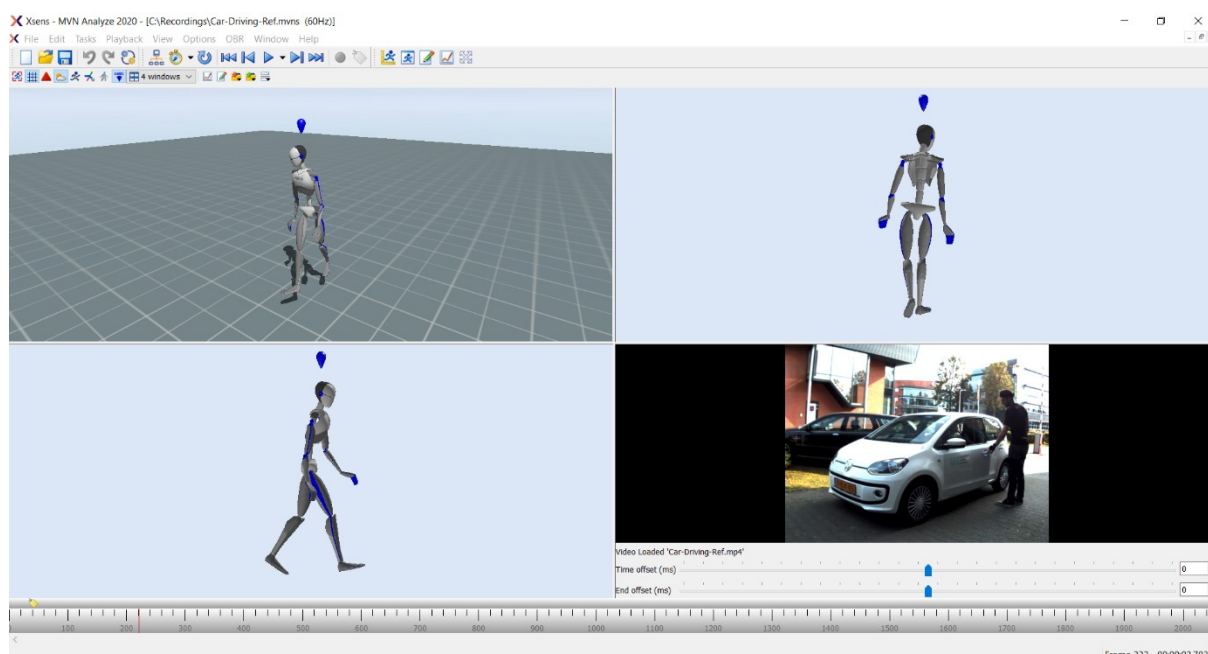

Figure 61: Video synchronization sliding bar

## 10.5 Contact point editing

The MVN Fusion Engine uses external contacts of the body with its surroundings to minimize position drift of the computed body model with respect to the Origin (defined by starting point). A number of points on the anatomical model have been defined that are likely to make contact with the external world. An overview of these potential contact points is given in the table below. The detection of external contacts is based on measured kinematics of relevant body parts. In some cases, e.g., when a recording is made on different floor levels (e.g. stepping on stage), it can be desirable to overrule the automatically detected contact points or manually set height levels.

**Note: that after processing the file with the Reprocess HD engine, contact editing should not be necessary.**

During Playback and Editing, four default bars appear above the timeline, indicating presence of contact points, advanced (floor level), position, and clipping edits (Figure 62). If there is a contact, the contact will be shown in the viewport with a large blue sphere. When hovering above the 'other contacts' bar a tool tip pops up indicating which contact point is active.

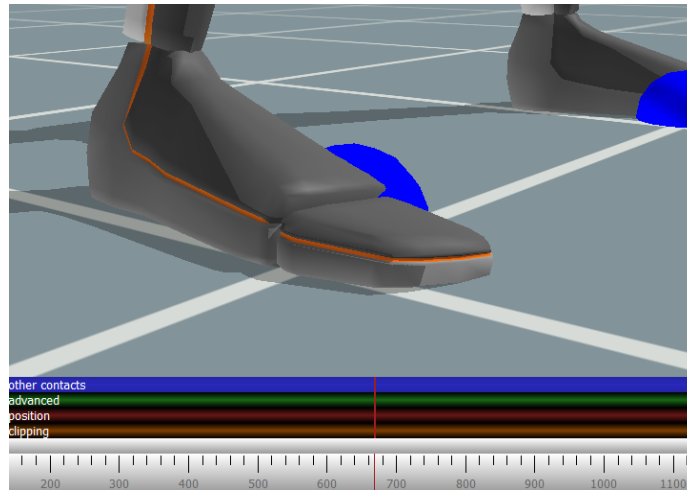

Figure 62: Contact point

When clicking on a body segment with the left mouse button, the selected mesh will light up in red. The selected body segment shows spheres with external points of that segment. The time bar will zoom in and expand to show the detected contact points of the selected segment per frame. The colours of the spheres correspond with the coloring and labeling in the contact bar. For example, on the foot, there are four possible contact points: the heel (blue), first metatarsal (green), fifth metatarsal (red) and the pivot point on the ball of the foot (pink).

Contact point	Description
HeelFoot	Heel of the foot
FirstMetatarsal	Inside ball of foot
FifthMetatarsal	Outside ball of foot
PivotFoot	Center ball of foot
TibialTub	Bony elevation on upper part of the shinbone (tibia)
GreaterTrochanter	Eminence on the upper part of the femur
IschialTub	Buttock (left and right)
Sacrum	Base of the Spinal Column
Central Buttock	Buttock
Anterior Superior Iliac	Bony projection of the iliac bone
PX	Bottom of sternum
T4SpinalProcess	Vertebra between shoulders
Acromion	Shoulder
Olecranon	Elbow
BallOfHand	Ball of hand
TopOfHead	Top of head

When an external point is defined as a contact, the related sphere will enlarge for the currently displayed frame. Clicking on a second segment will show the contacts of both selected segments.

To scrub, drag the time line scroll bar (↔) to the left or right. Step through the time frames using the left and right cursor or keep it pressed to move very slowly through the file, frame by frame.

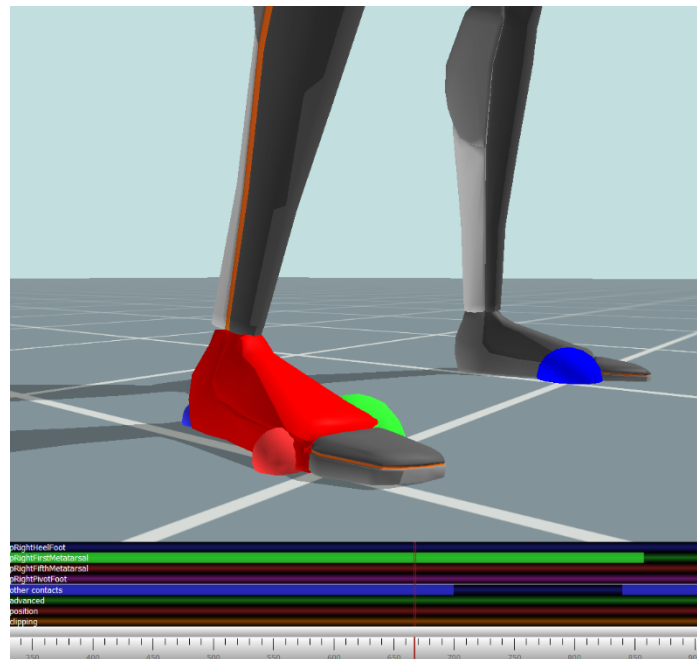

Figure 63: Contact points on the 3D viewport and the contact editing menu

### 10.5.1 Selection of samples

The left mouse button (and drag) will set a contact for the selected contact point. The color of the user-defined contact point will be slightly darker than the color of the original detected contact point. Only one contact point can be selected per segment. To select contact points for multiple segments, hold the shift key during selection with the left mouse button.

**Note: The first contact editing action will take more time than the succeeding actions due to the caching mechanism.**

The right mouse button (and drag) will show the contact point editing options for the selected frames. In the next section, these options will be explained.

To ensure that the changes are applied, click reprocess – see Section 10.5.2.6.

Undo ('Ctrl + Z') and redo ('Ctrl + Y') the performed contact point editing actions. Saving the file commits the changes and they can no longer be undone.

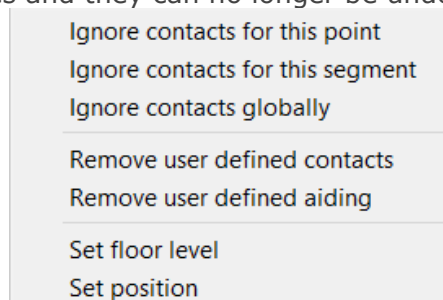

Figure 64: Right click menu in contact editing



## 10.5.2 Contact point editing options

### 10.5.2.1 Remove user-defined

Revert to the original recording for the selected samples. Remove user-defined aiding refers to the positions and floor levels set, as remove user-defined contacts refers to the contact points of the segments. Reprocess to apply changes (see Section 10.5.2.6).

### 10.5.2.2 Ignore contacts globally

Removes all detected contacts for all segments.

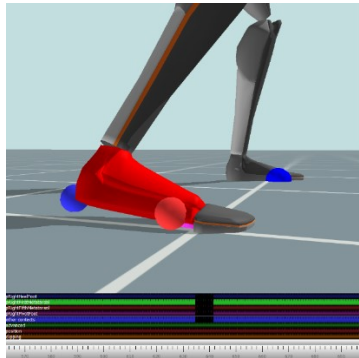

Figure 65: Example of ignore contact globally

### 10.5.2.3 Ignore contacts for this segment

The selected segment will not make contact for the selected samples. The MVN Fusion Engine will mark the most likely point of another segment as a contact.

### 10.5.2.4 Set position

Sets the position and its uncertainty for the selected contact point. Optionally, only the height of a point can be set. Set positions can be found in the set position bar. With the position aiding interface, it is possible to set a contact point at a desired coordinate (X, Y and Z). This can be useful in situations which are not supported by one of the user scenarios (e.g. walking stairs). Examples: (1) the starting position of a recording can be set to zero, (2) when the subject is hanging on a bar, the position of the hands can be fixed at a given height, (3) when a subject steps onto an object, the height of the contact can be 'frozen' to the height of the object, (4) when a subject jumps down from an object, the position of the foot can be set to the height of the object before jumping. Note that some situations, such as walking on an elevated surface can also be accomplished by setting the floor height.

In the contact bar, right-click the desired time frame(s) and select the option 'set position'. In the dialog, the X, Y and Z positions of the selected segment point of the current time frame are given.

**Note: in MVN Analyze/Animate, height is indicated by 'Z'.**

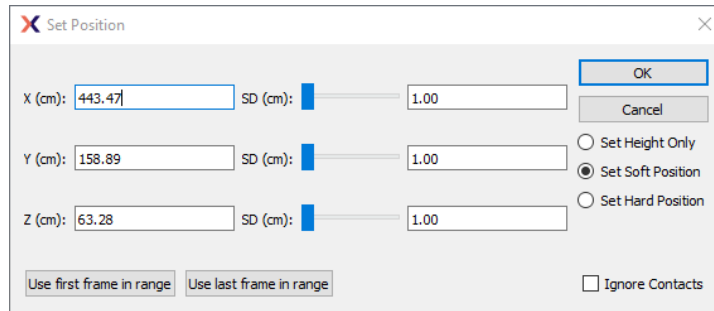

Figure 66: Set position menu during contact point editing

The SD slider sets the standard deviation, which is an indication of how much the aiding point can be trusted in combination with the computed position of the MVN Fusion Engine. This option can also be used creatively for example to create a “soft” landing on a mattress. With the ‘Force no contacts’ options, no other contacts will be detected during the selected frames. The contact bar will show a dot in the center of the edited frame and mark all other contact points dark. The ‘Absolute’ option completely overrules the computed position of the MVN Fusion Engine. The contact bar will show a ‘P’ at the selected frame. After editing the co-ordinates, click the reprocess button.

Always work chronologically when setting positions of contact points, since an edited position at frame  $k$  will influence the position at frame  $k+1$  and further.

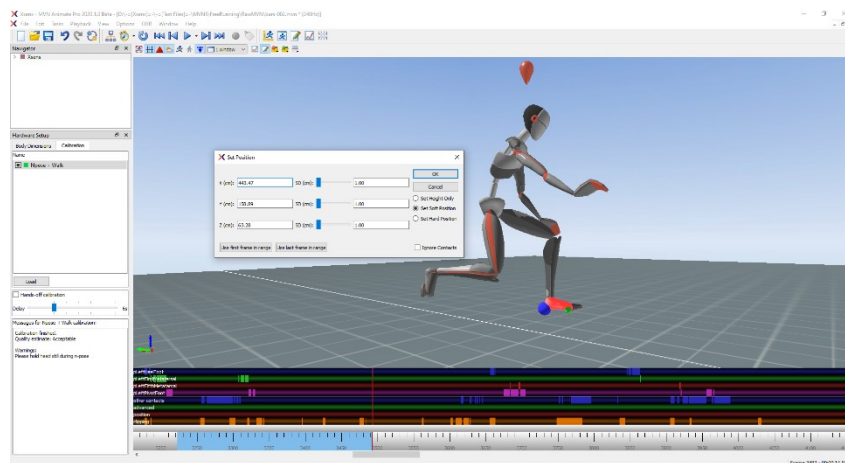

Figure 67: Example of using contact point aiding for seated position

### 10.5.2.5 Floor level

Sets the height of the floor. Multiple floor levels can be set in one file. The current floor level is presented in the dialog; see

Figure 68 for an example.

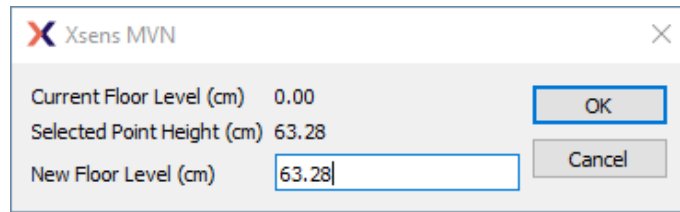

Figure 68: Set floor level menu

Right mouse click on a contact bar to set the floor height to the height of that contact. The contact detection will now be applied on the new floor height for all following samples.

Left mouse click and drag on the advanced bar allows you to set a floor height for a range of frames

#### 10.5.2.6 Clipping

The clipping bar indicates when clipping has occurred in the data. This gives users an indication of when movement has caused sensor data to be exceeded. Data should not be trusted at these times.

### 10.6 Multi-person editing

In the MVNS file, the contact and aiding points for each character can be edited separately. Click on one of the segments of the character you want to edit and follow the workflow as described in Section 10.5.

The body dimensions and scenario can also be changed in the calibration for the selected character.

For each suit, a separate export file will be generated when exporting to MVNX, BVH or FBX, C3D see Section 15.

## 11 On-Body Recording

On-body Recording' allows you to record motions everywhere without the need for a laptop or PC by storing motions on the Body Pack (only for MVN Link). The Body Pack has internal memory that has the capacity to record up to 15 hours of data. This functionality is enabled by a firmware update (Body Pack firmware 1.1.4).

### 11.1 Configuration

To configure the Body Pack for On-Body Recording go to: Options > On-Body Recording

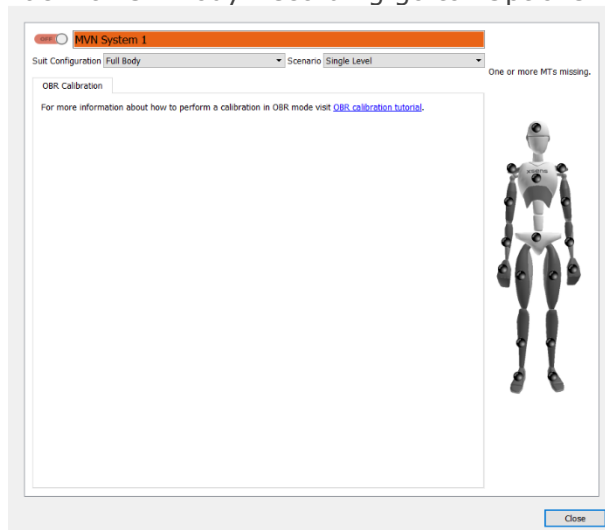

Figure 69: On-Body Recording configuration window

The top part of this dialog is intended for Device Configuration. Here you can enable or disable On-Body Recording and set the details of your recording, like Name, Update Rate, Suit Configuration, Scenario.

See also the tutorial on how to configure the Body Pack:  
<https://tutorial.xsens.com/video/enable-disable-on-body-recording/>

### 11.2 Calibration and recording

When using On-Body Recording you will not be guided by MVN Analyze/Animate which requires you to perform a calibration before you can actually start recording. You will need to start your recording session with a separate calibration recording (Npose + Walk or Tpose + walk as explained in tutorial video '[Setup and calibration MVN Link](#)' or as described in 8.1 Calibration). It is essential to do this calibration recording with care and take time to stand in a proper Npose or Tpose for 5-10 seconds, following by walking back and forth for 5-10 meters. Further instructions on Calibration and Recording can be seen in the tutorial video: <https://tutorial.xsens.com/video/perform-an-on-body-recording-calibration>

### 11.3 Import Recordings

Once you are finished with recording you can connect the Body Pack to the PC to import the recordings. Go to: Options > On-Body Recording

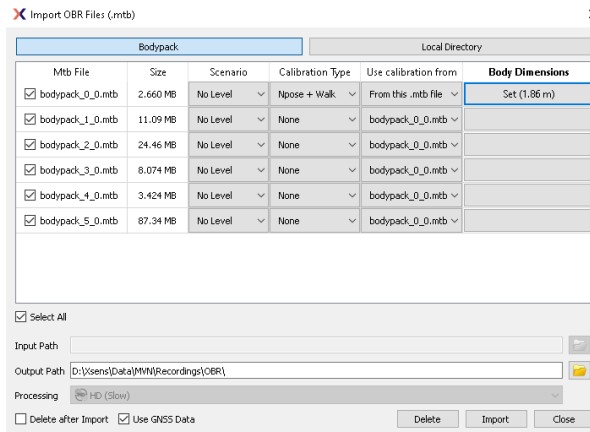

Figure 70: import MTB files menu

The bottom part of this dialog allows you to manage the recordings on your Body Pack. You can select the recording that contains the Npose + Walk or Tpose + Walk, which can then be applied to the other recordings. Body Dimensions and Scenario can be set here before you import it to a specific path on your pc.

See also the tutorial on 'Importing On-Body Recording files':

<https://tutorial.xsens.com/video/importing-on-body-recording-files/>

## 11.4 Swap Trackers

The ability to swap tracker strings is now available within MVN Analyze. The option to do this is found in the OBR tab. Click on the OBR tab, followed by the swap trackers tab.

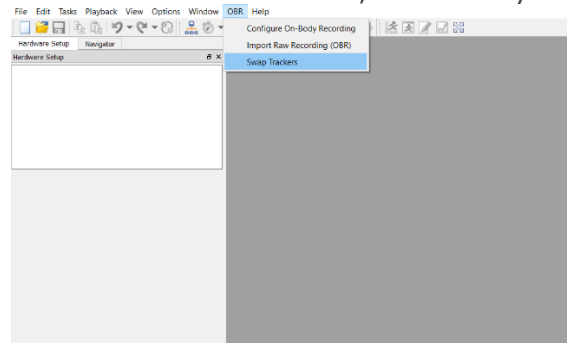

Figure 71: OBR, swap trackers

Following this, you will be directed to the swap tracker window. Place the location of the folder containing the files you wish to swap tracker strings under Input Path, once this is selected a list of the files will appear in the file column.

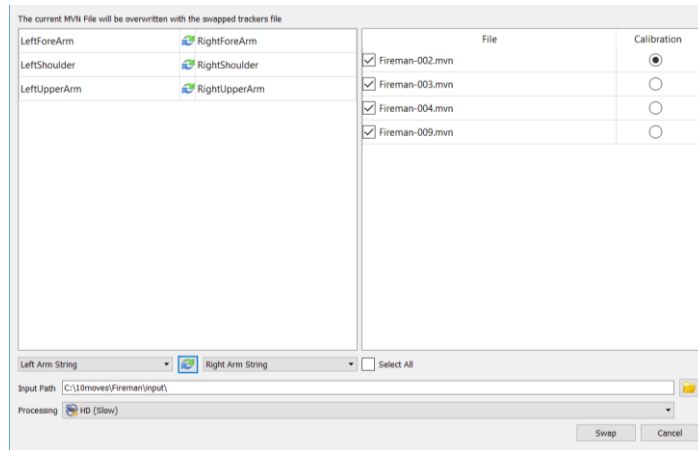

Figure 72: Swap trackers configuration

Select the strings you desire to swap and click on the green and blue circular arrows, these will appear in the swapped trackers list. Select which processing mode you desire and finally click Swap.

### 11.5 Remote On-Body Recording

The Remote On Body Recording (Remote OBR) feature allows you to synchronously trigger multiple body packs to initialize and stop the On Body Recording (OBR) functionality. To set this feature up, first ensure each Body Pack is configured to OBR in the "Configure On-Body Recording" tab. Once each Body Pack is configured, ensure your Access Point is switched on and open up the "Remote OBR" tab (Figure 73).

Xsens - MVN Analyze 2020

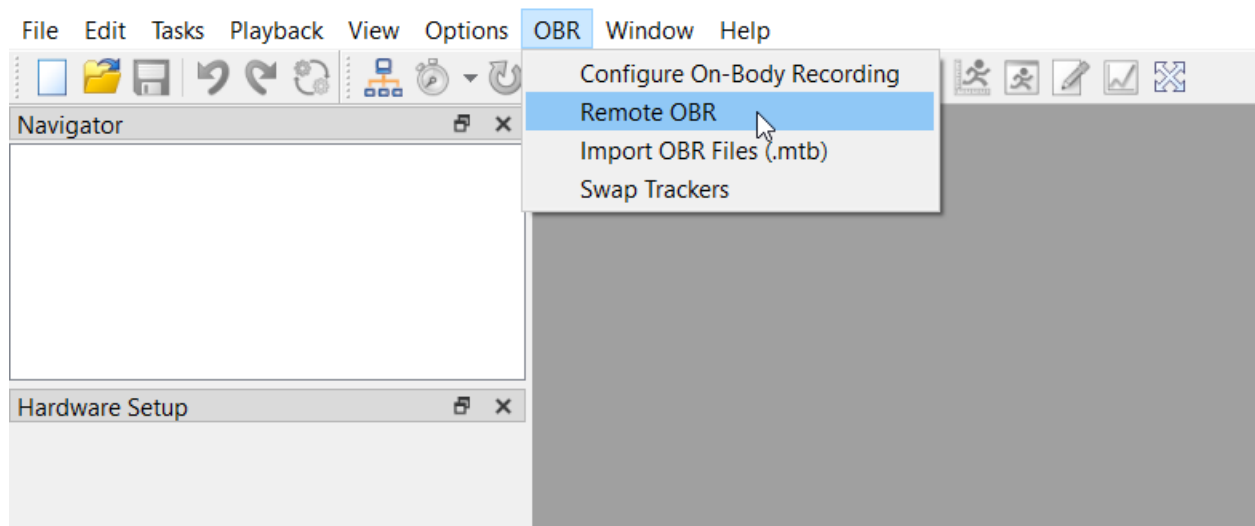

Figure 73: Select Remote OBR

After pressing this tab, the following interface will appear (Figure 74).

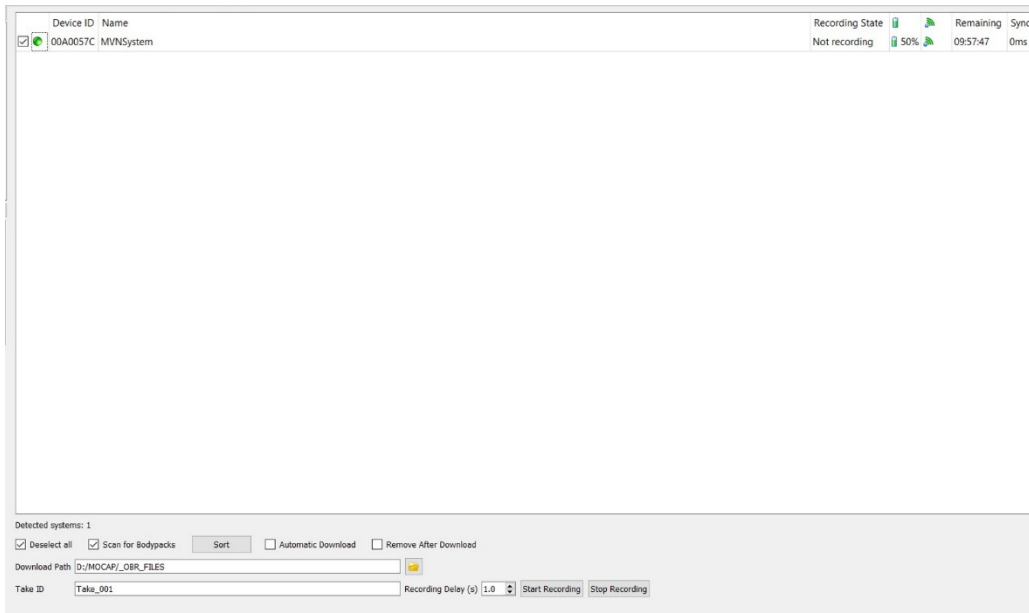

Figure 74: Bodypack Configuration interface

The Access point will begin scanning for the Body Packs, once discovered, each Body Pack will appear with the Device ID and Name with the ability to select/deselect which Body Pack you want to record with. For each Body Pack the Recording status, battery status, Wi-Fi strength and Sync is also listed on the right side of the interface. The sync refers to the measured system clock deviation at the time of synchronization in milliseconds.

At the bottom of the interface you can select/deselect scanning for Body Packs as well as deselect all. To name the take, type in the name in the TakeID section. To start and stop recording, push each respective button on the bottom right corner. You also have the ability to set a recording delay in seconds following the press of the start button.

<https://tutorial.xsens.com/video/remote-on-body-recording-robr>

From MVN 2020.2 onwards, you can transfer OBR file (.mtb) from Bodypacks to your computer wirelessly. Make sure to update the hardware with the latest firmware. In the bottom of panel of Figure 74, you can find two checkboxes and one user input.

**Automatic Download:** If this box is checked and Bodypacks are successfully connected via WIFI, OBR file (.mtb file) will be automatically copied from all connected Bodypacks to your host computer. When the file is being recorded, it will not be transferred. Once a recording is finished, it will be automatically transferred for that file. Unchecking this checkbox will stop any active file transfers.

**Remove After Download:** If this box is checked, OBR files in Bodypacks will be deleted after successful transfer.

**Download Path:** This path is the destination path for saving .mtb file. You cannot change the path during file transfer.

## 12 3D Position Aiding

### 12.1 GNSS

#### 12.1.1 Introduction

The recent addition of GNSS (Global Navigation Satellite System) to Xsens MVN allows position aiding to your inertial motion capture. The GNSS refers collectively to GPS (USA including QZSS (Japan) and GLONASS (Russia) for this 1<sup>st</sup> release. These global positioning systems work all over the world including China and Japan, however the 1<sup>st</sup> release does not support BeiDou, which is optimal for China. GNSS has several benefits for your motion capture applications.

- i) One of the first major benefits allows position to be measured for applications that do not contain clear defined foot-strikes. Typically inertial motion capture calculates 3D position, by using the orientations of all of the segments in the linked segment model and in turn, calculating the postures in between foot contacts with respect to a global origin. However, for applications that do not contain foot strikes, such as cycling, skating, skiing, kayaking, horse-riding and several other vehicle based scenarios.
- ii) Second, it may reduce the effects of positional drift over time with respect to a global origin.

However, it should be noted that the position is reliant on the accuracy of the GNSS signal itself, as this is what informs position and heading of the underlying biomechanical model. GNSS typically has an accuracy of up to 1 meter with respect to latitude and longitude, however there are several factors that can influence this accuracy. Some of these factors include:

- The position of the antenna, we recommend placing the antenna on the shoulder, such that it points up at the sky.
- Being in areas with a high density of buildings, this can influence the triangulation of the antenna with the satellites.
- Moving into areas in which the antenna is blocked off completely, such as entering a tunnel.
- The movement of the participant being measured, typically if the participant is stationary, the satellites take a bit longer to get a fix on the position.

It is important to note, that the 1<sup>st</sup> phase of the integration of GNSS to inform position, does not use elevation, but only latitude and longitude. This is due to the fact that errors are much greater with elevation measurements, and in some cases can be up to 5 m. Thus, only latitude and longitude are used to measure the position along the XY plane with the pelvis locked in the Z direction. This must be taken into account for applications that have significant hills or mountainous regions.

#### 12.1.2 Set up with GNSS position aiding

The GNSS antenna plugs into the Body Pack on the very right, by screwing in place. The antenna can then be placed on the top of the shoulder, we recommend placing it on the right shoulder with the antenna pointing towards the sky. Velcro patch can be placed on the antenna and suit, but it can also be placed above the shoulder sensor in the compartment of the lycra suit. Ideally, it should be pointed up at the sky as much as possible to improve the strength of signal.



When configuring a new session, open up the Position tab (Figure 75) and select the GNSS option. When this is enabled, the system will record and use the data collected from the GNSS antenna. The scenario can be set to 3 scenario's: Single level, Multi level and No level.

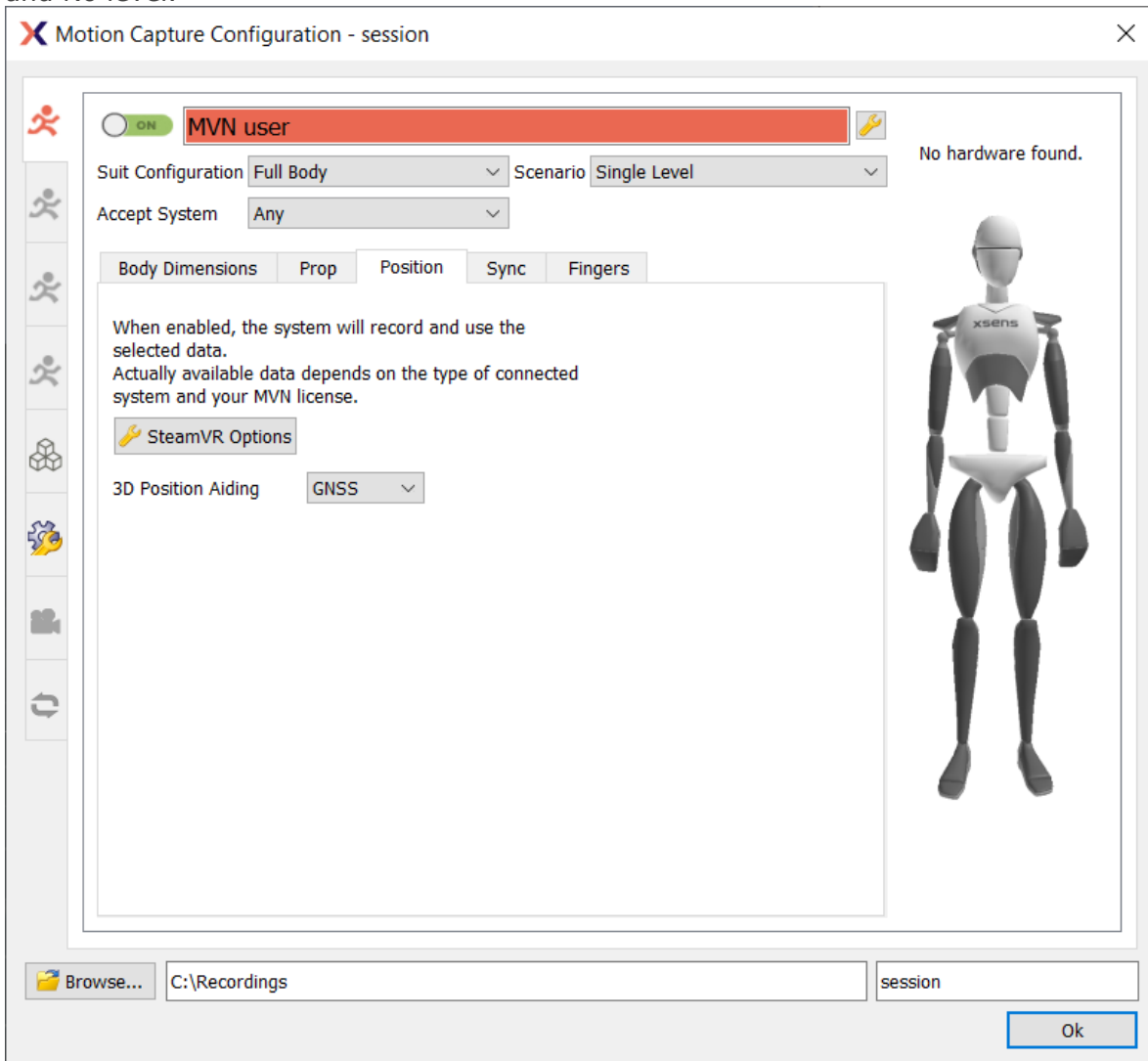

Figure 75: Position tab in the Motion Capture configuration

When recording during a live session, the GNSS will show latitude and longitude in the bottom graph titled "Global Position Data (deg)" (see figure below), as well as the GNSS Accuracy in meters in the top graph titled "GNSS Accuracy data (m)". Following HD reprocessing offline, the Avatar will move on the grid with respect to the global origin that was set (Figure 76).

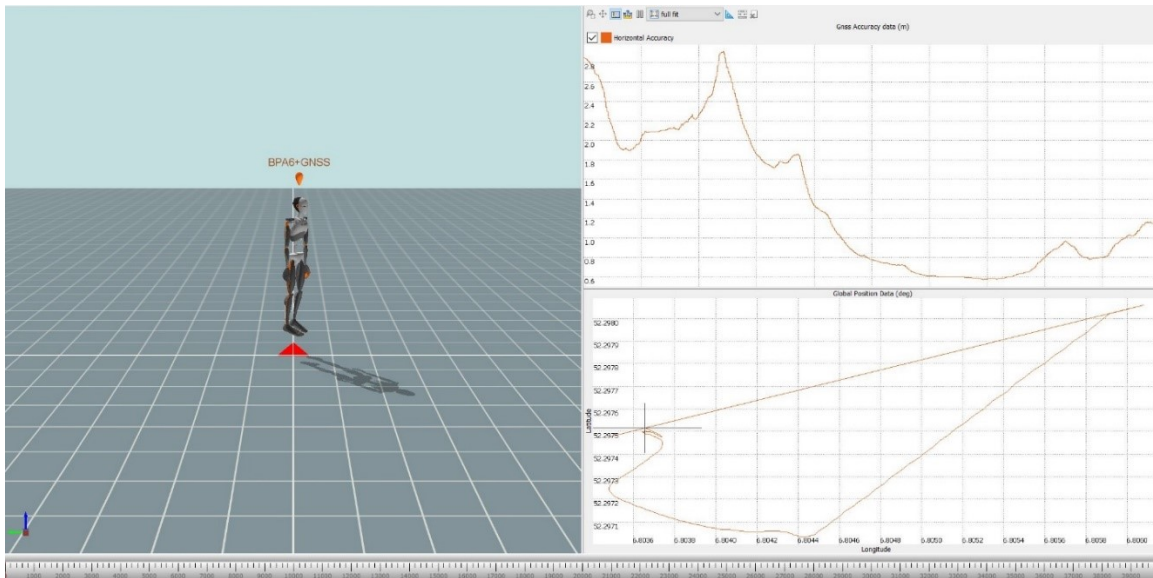

Figure 76: GNSS set-up in MVN

It is also possible to set-up the GNSS in On-Body Recording (OBR), by opening up the Configure On-Body Recording tab, selecting Data and checking the GNSS checkbox.

## 12.2 HTC Vive

### 12.2.1 Background

MVN allows for position aiding with HTC Vive. With the feature, the MVN fusion engine combines the Motion Tracker data from the Motion Capture System (Link or Awinda) and the HTC Vive position tracking to improve the global position. This can be extended to multiple systems, improving the multi-actor alignment and optimizing the workflow. The Position Aiding can be viewed live as well as HD processed after recording. It can be used in the following Scenarios:

Scenario	Explanation
Single Level	Actor is moving on a single plane
Multi Level	Actor is moving on more than one plane (e.g. jumping on a table, walking stairs)
No Level	Actor has no contacts with the environment (e.g. skating, cycling). No contacts are used in this Scenario, which might result in foot slide. For no foot slide, use the Single or Multi Level Scenario)

This chapter helps you to set up a recording with HTC Vive Position Aiding.



<https://base.xsens.com/hc/en-us/articles/360012351440-Position-Aiding-HTC-Vive>

### 12.2.2 Vive Hardware placement

The Vive Hardware can be used in multiple locations on the body for position aiding. The Segment closest to the location of the Hardware will be most accurate. So, if you are most interested in Hand location, for example, if you are recording a high five between actors, it is advised to place the Vive Trackers on the forearms of the actors.

Below you can find an overview of the locations you can mount the Vive Hardware on.

Vive Hardware	Location	visuals
	Pelvis	<p style="text-align: center;"><b>Pelvis</b></p>  <p>Place the Vive Tracker just above Pelvis Motion Tracker</p>
	Fore Arm (R/L)	<p style="text-align: center;"><b>Forearm</b></p>  <p>Place the Vive Tracker at 1/2 of the forearm (halfway from wrist to elbow) on the outer side of the arm in n-pose.</p>
	Lower Leg (R/L)	<p style="text-align: center;"><b>Lower Leg</b></p>  <p>Place the Vive Tracker at 1/3 of the lower leg (one-third from the ankle to the knee) on the outer side of the arm in n-pose.</p>
	Head	<p style="text-align: center;"><b>Head</b></p>  <p>Place the headset on the head, as if you are playing a virtual reality game</p>

	Hand (R/L)	<div style="border: 1px solid black; padding: 5px;"> <div style="background-color: #f4a460; text-align: center; padding: 2px; font-weight: bold;">Hand</div> <div style="display: flex; justify-content: space-around; align-items: center;">   </div> <p style="font-size: small;">Hold the controller in your hand as if you are holding it, playing a game</p> </div>

### 12.2.3 Setting up

To work with HTC Vive as positional aiding, make sure you set up Steam, Steam VR and HTC Vive. Please follow the steps in the BASE article below.

<https://base.xsens.com/hc/en-us/articles/360012457659-HTC-Vive-Setup-Guide>

Placement of the Vive trackers on the body is explained in this tutorial:

<https://base.xsens.com/hc/en-us/articles/360012351440-Position-Aiding-HTC-Vive>

After you have set up HTC Vive, you need to start an MVN live session:

1. Open MVN
2. Start a new live session (by clicking the Blank page icon)
3. Follow the normal procedure in setting up a system. To enable positional aiding go to the Position tab (Figure 75)
4. Select HTC Vive (Figure 77)

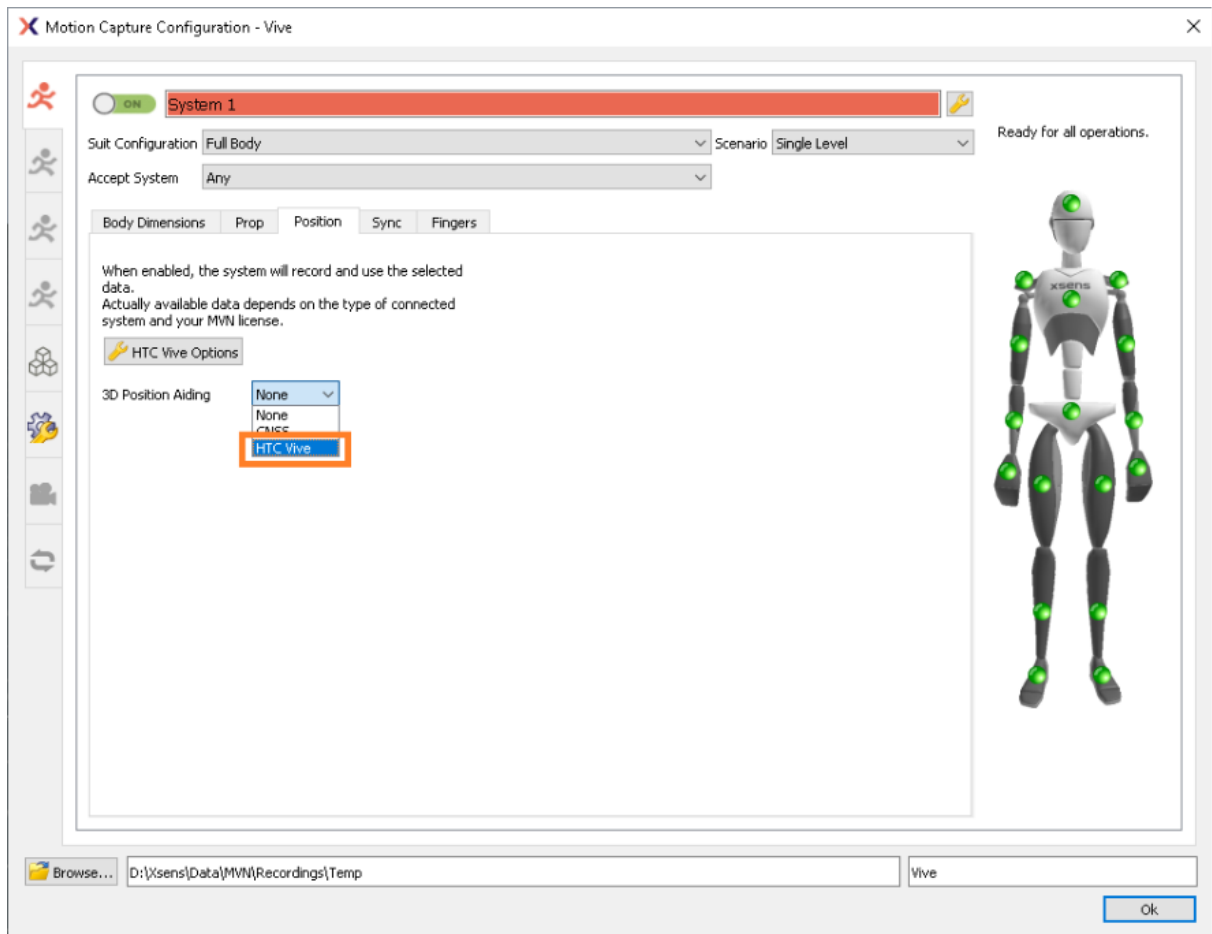

Figure 77: Motion capture configuration - Position - HTC vive

**Note: An octagon will appear on the avatar to indicate the status and location of the Vive trackers:**

Icon	Color	meaning
	green	Vive Ready and receiving position data
	yellow	Vive Tracker ready but not receiving position data.
	black	No Vive Tracker detected

5. In the TrackerID drop-down menu (Figure 78), select the Vive Tracker ID to attach to this actor. You can use multiple Vive Trackers / Controllers / Headset per actor, which all contribute to determining the position of the actor. For all hardware you want to use for Position Aiding, select a Location.

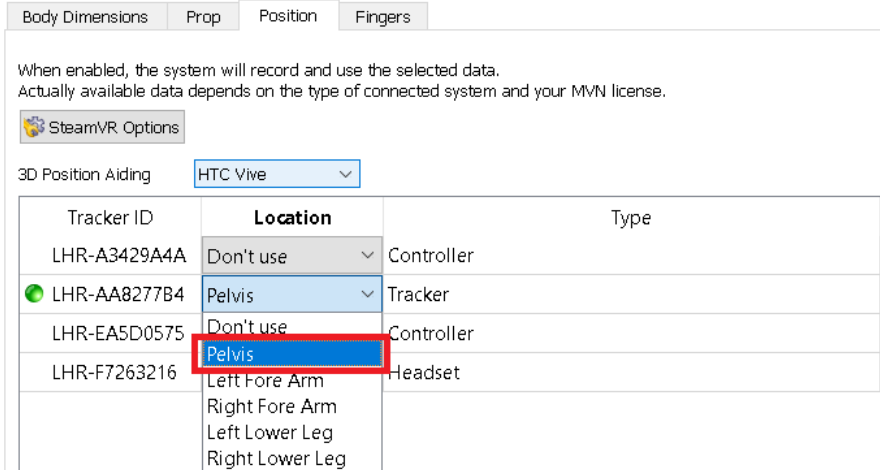
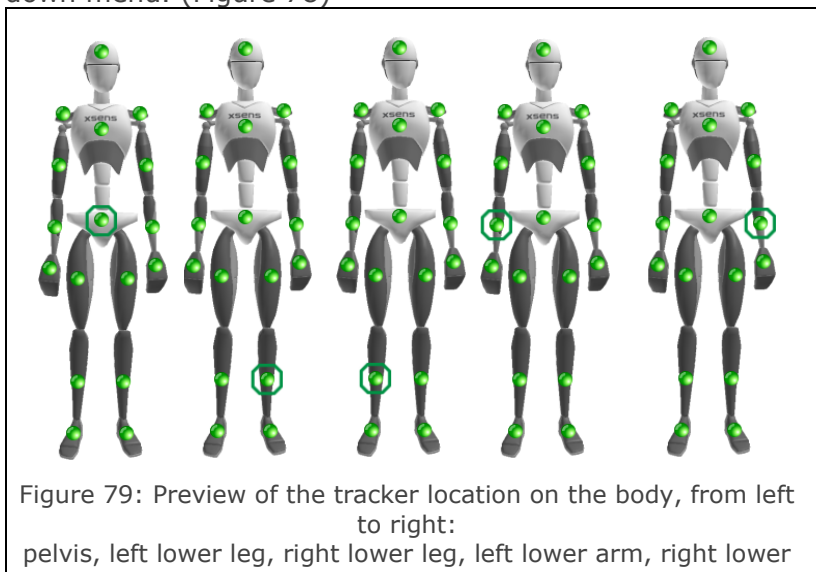

Figure 78: Select the Vive Tracker ID to attach to this actor

6. Select the location on the body where the tracker is placed at the Location drop down menu. (Figure 78)



7. Click Ok to start the live session
  8. Perform a regular calibration
    - Link (<https://tutorial.xsens.com/video/calibrating-link/>)
    - Awinda (<https://tutorial.xsens.com/video/calibrating-awinda/>)
- Typically, MVN will reset the Axis and Position based on the Vive data. In some cases, if there is not enough data collected, MVN indicates "System is not yet configured correctly for Vive data, please perform an Axis Reset.

**System 1 is not yet configured correctly for Vive data, please perform an Axis Reset  
Stand in N/Tpose**

Walk around inside the bounds of the Vive Play Area.

**Calibrating Vive for System 1, please walk around.**

MVN will automatically detect the movement. Keep on walking around until the process bar is completed.

**Calibrating Vive for System 1, please walk around.**

## Recording

After calibration, you are ready to record.

1. Make sure you are in the bounds of the Play Area.
2. Press the Record button (or Ctrl + R) to start the recording.
3. Press the Record button (or Ctrl + R) again to stop the recording.
4. MVN will create the following file type(s).
  - .mvn file: contains the Position Aided Motion Capture Data
    - M** Take-001\_Steven.mvn
    - .mvno file: contains the positional and rotational data from the Objects (only created if Object Tracking was enabled during the session, see chapter 12.2.4)
  - O** Take-001\_Objects.mvno
    - .mvns file: contains the Mocap Data and Objects Data combined in a session (only created if Object Tracking was enabled during the session or multi person).
  - M** Take-001.mvns

More info can be found here:

<https://base.xsens.com/hc/en-us/articles/360012446260-MVN-File-Types>

After processing, the Xsens Fusion engine has combined the MVN Motion Capture data with the Vive position data, resulting in Position Aided Motion Capture data (.mvn file). This data can be exported like any other .mvn file.

**Note: with multi-actor sessions, it is still important to perform an Axis Reset (in MVN > Tasks > Axis Reset, or Ctrl + Alt + A) to align the heading of the actors.**

#### 12.2.4 Object tracking

MVN Analyze/Animate Pro can also track, record, stream and export free-floating Objects (like cameras, tables, chairs, etc.) that have their own HTC Vive tracker connected.

Note: not to be confused with 'Props' in MVN, which are always connected to a specific actor.

See the following BASE article for more information about Object tracking:  
<https://base.xsens.com/hc/en-us/articles/360012457639-Object-Tracking-HTC-Vive>

### 13 MVN Remote app for iOS and Android

MVN Remote is an app that allows you to control MVN Analyze/Animate from your phone or tablet. The app can also record a reference video using the camera on the device. This video will be streamed to MVN Analyze/Animate and can be played back next to the motion that was recorded (Figure 80).

<https://base.xsens.com/hc/en-us/articles/360010738879-MVN-Remote-App-for-iOS-and-Android>

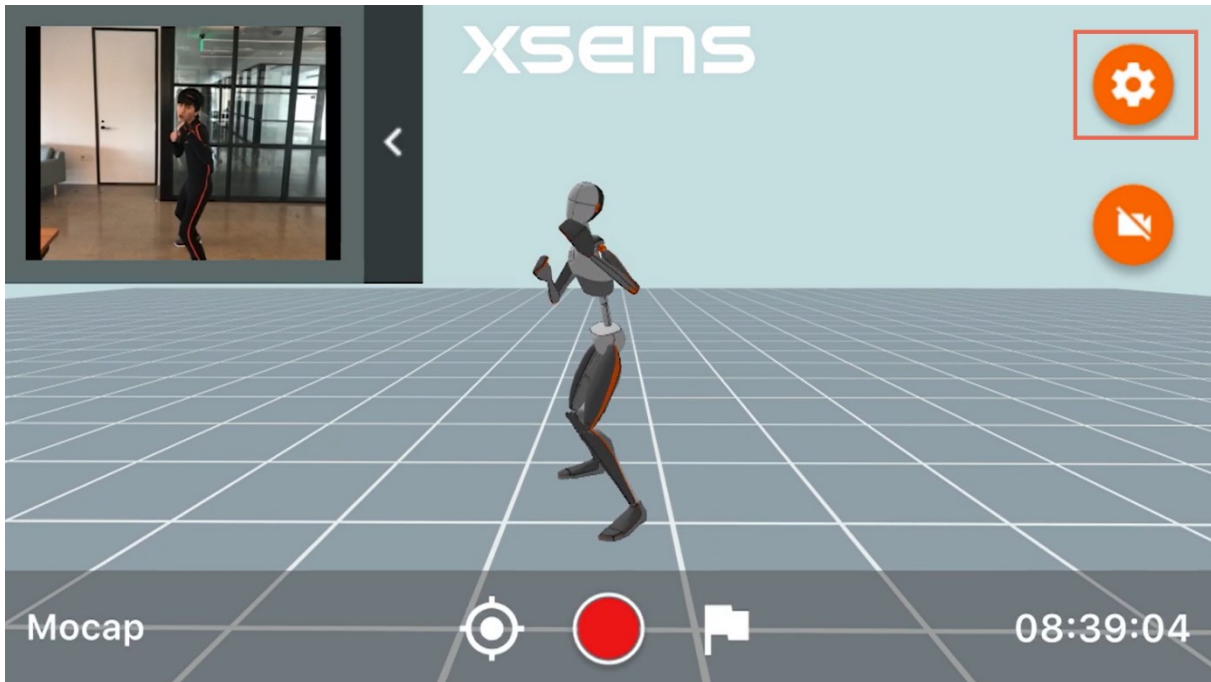

Figure 80: Remote app interface

The app is available for both [Android](#) and [IOS](#).



## 14 Data Analysis

The final stage of the work flow is 'Data Analysis'. The major feature of the analysis stage is kinematic graphs.



### 14.1 Graphs

In the analysis workflow stage, a graph appears in the interface. To view a graph of a given parameter, click and drag the parameter from tree view to the graph. Two types of graphs are possible: time vs. parameter and parameter vs. parameter (Coordination [or phase] Plots).

#### 14.1.1 Parameter vs. Time

Drag and drop a parameter with the left mouse button to create a parameter vs. time graph. Click on the colored boxes in the legend to disable/enable data in a given plane.

#### 14.1.2 Overlay graphs

Drag and drop the desired parameter with the right mouse (or left mouse + Alt) button into the data analysis window that contains the initial parameter/s. From here, select the option "Add to graph" from the drop down menu to display the parameters together (**Figure 81**). You can click on the coloured boxes in the graph legend to disable/enable data from the desired plane.

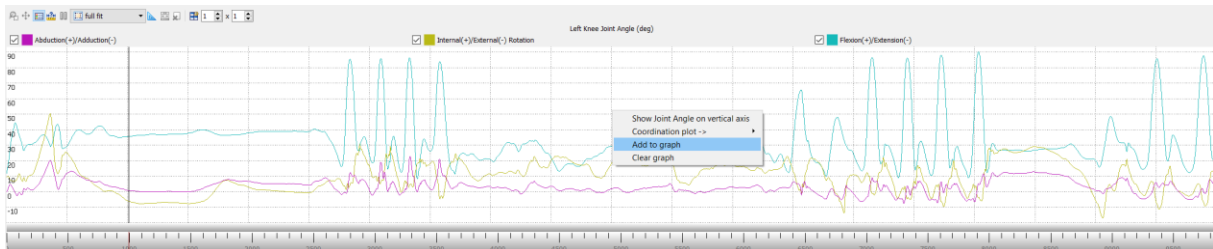

Figure 81: Overlaying Graphs of multiple parameters

#### 14.1.3 Coordination / Phase Plots (Parameter vs. Parameter)

Drag and drop a parameter with the right mouse button to the horizontal or vertical of the graph to create a parameter vs. parameter graph. Select the variable to plot from the menu. On the remaining axis, another axis of the parameter will be displayed as default. Repeat the process to plot the desired parameter on the remaining axis.

**Note: The graphs show the angular velocity in degrees per second. In MVNX files, the angular velocity is exported in radians per second.**

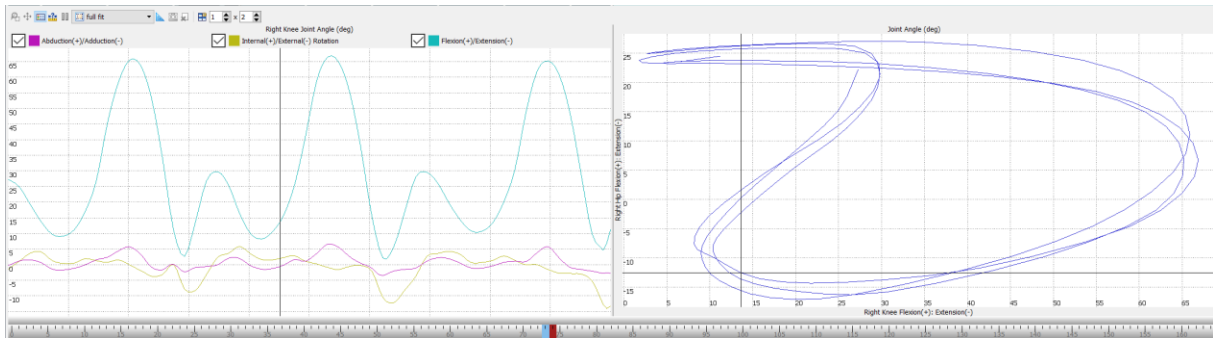

Figure 82: Time vs. Parameter on the left hand side and parameter vs. parameter on the right hand side

#### 14.1.4 Graph handling

Zoom and pan in the graph using the icons in the toolbar. The time on the time vs. parameter graphs conforms to that shown in the time bar.

#### 14.1.5 Graph toolbar

Icon	Task
	Zoom
	Pan
	Show/hide legend
	Show numerical value on graph
	Freeze graph (not yet available)
	Scaling options: Full fit, Expand to fit, No auto scaling
	Equal axes
	Show all samples (always on)
	Clear graphs (not yet available)
	Amount and layout of graphs
	Horizontal / Vertical graph view (on main toolbar but used only in combination with graphs)

#### 14.1.6 Scaling Options

Scaling option	Functionality
No auto scaling	Y-scale will no longer be scaled
Expand to fit	Y-scale will be stretched to show all data in plot
Full fit	Y-scale will be stretched to show all data in plot

### 14.1.7 Zoom

To zoom, select the “No auto scaling” option. Zoom only takes place on the vertical axis. To zoom in time use the mouse wheel in the time line to zoom horizontally to a point in time.

### 14.1.8 Pan

To use the pan function, enable “no auto scaling”, click in the graph area with the left mouse button and drag up or down, to pan. Note that it is not possible to pan to an area with no data. When data is available beyond the limits of the vertical axis it is possible, using the cross bar to pan, and also using a purple scroll bar, which appears on the side of the graph when there is a large difference between vertical values, as Figure 83 shows.

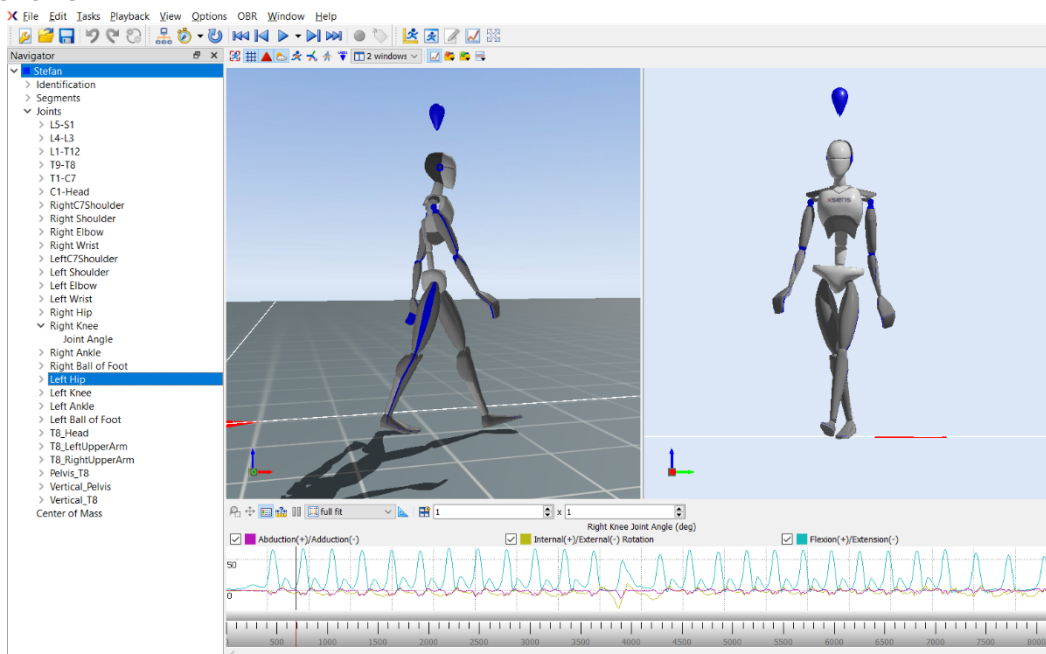

Figure 83: Pan and Numerical Values on Graphs

### 14.1.9 Show/ Hide Legends

Often it is already understood what the colors of the graphs represent. To save room, the legends can be hidden by toggling the Show / hide legend icon.

### 14.1.10 Show Numerical Values on Graphs

Using this icon, the numerical value on the graph is visible. It is possible that at times the lines intersect and the values are not clearly visible, when this happens; remove one line from view by disabling this in the tick box in the legend. In this way the value of one line at a time is made visible. See Figure 83 for an impression of how the numerical values appear in the graph.

### 14.1.11 Equal axes

This tool is used with the phase / coordination plots. Toggle between Equal Axes and “Full Fit” depending on the detail required.

#### 14.1.12 Amount and layout of graphs

There are a number of pre-defined layouts available, which can be selected from the drop down menu. Additionally, there is a possibility for the user to define a custom amount and layout of the graphical representation. When "Custom" is selected, a new area appears where the user can insert the number of rows by columns to view.

### 14.2 Cascade / Tile windows

Multiple trials can be opened simultaneously and played and edited. Viewing a live performance is also possible in playback. Use the 'Window > Cascade / Tile' menu to select the window layout.

### 14.3 Linked views

When multiple windows are active, their views can be linked. Upon enabling Linked Views, the scene of all windows will be reset such that the origin faces the same direction. When the view in one window is changed, the view in the other window will change accordingly. Use 'Options > Linked Views' to toggle the linked views option.

### 14.4 Marker List

The marker list enables you to observe where you have placed your markers throughout your trials, simply click the view tab and select "Markers". The marker list will appear in an interface that you can move anywhere depending on your preference. To set a marker, right click on the timeline where you would like to place it, input a name for the marker and the frame, and it will appear in the marker list (Figure 84).

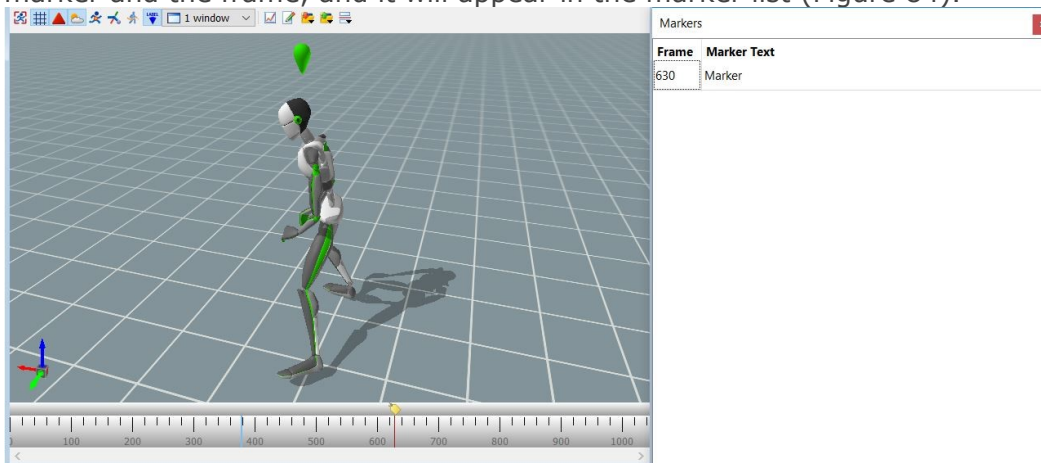

Figure 84: Marker list

## 15 Saving and Exporting

When a recording has been made that contains more than just the motion data of a single actor (e.g. multi-actor or video), two files are created and saved automatically, one with the file extension “.mvn” and the other with the file extension “.mvns”. If synchronized video data is recorded, a movie file “.mpg” is also saved automatically.

MVN (MVN native file) is the most comprehensive format and contains all measured inertial sensor data, and all kinematic data of each segment. It is a binary proprietary format and can only be used by MVN Analyze/Animate or by using the SDK. The MVN files contain all original data and can be used to re-process a recording using other settings. To copy a part of an MVN file to a new MVN file, select the frames and go to >Edit >Copy selection to new MVN file, press ‘Ctrl+B’ or right click the Timeline.

MVNS is the MVN session file. It contains information about the recorded trials, it is necessary to open an MVNS file if video data was recorded, or to playback and edit time-synchronized multi-person recordings.

If video data was recorded, opening the file with extension mvn will open only the MVN data – the 3D character in the viewports. Therefore to watch synchronized video data with the MVN data, open the file with the “.mvns” extension, which will call both the .mpg and the related .mvn files.

If MVN Analyze/Animate was used for multi-person capture, data of each character is saved in a separate MVN file, which is synchronized based on the internal clock of the XMs for each suit. This means that for long files, the number of frames between simultaneously recorded MVN files can differ. However, these MVN files are grouped in the MVNS file. All recordings in an MVNS file are opened in the same 3D viewport and will be played back simultaneously. In the MVNS file, all tracks have the same number of frames. The MVN files will all have the same session name with the suit number as a suffix. For example, the MVNS file ‘Skating-002.mvns’ consists of two MVN files: ‘Skating-002-suit00.mvn’ and ‘Skating-002-suit01.mvn’.

MVN (MVN and MVNX) files can be exported to C3D, FBX, BVH or MVNX format. Before exporting a file to a given format, ensure that the settings are correct. To do this, go to >Options >Preferences >Exporters. Then go to >File >Export >Export File and select the desired export format. For batch processing of all active captures, go to >File >Export >Export All Open Files. For batch processing of a complete folder, go to >File >Export >Batch export. To export only a selected portion of an MVN or MVNX file go to >File >Export >Export Selection.

There are five main exporters, BVH, C3D, FBX, MVNX, and a Movie Exporter. Each exporter has its own menu in the preferences section.

If working with an MVN Basic or MVN Animate/Analyze plus there exporting functionalities can be accessed through a MotionCloud subscription. MotionCloud can be accessed directly through MVN or via a separate web-browser.

### 15.1 BVH

The name BVH stands for BioVision Hierarchical data, and embeds captured motion data in ASCII format which can be imported in many animation applications.

A BVH file consists of two parts, a header section which describes the hierarchy and initial pose of the skeleton; and a data section which contains the motion data. The start

of the header section begins with the keyword 'HIERARCHY'. The following line starts with the keyword 'ROOT' followed by the name of the root segment of the hierarchy to be defined, usually the hips. Each segment contains a vector indicating the length and direction from the parent segment. The vector is specified by the keyword 'OFFSET' followed by the X, Y and Z values. The 'CHANNELS' keyword indicates the number of channels for this segment (usually 3 Euler angles) together with the order of rotation. On the next line, either you will find the 'JOINT' keyword or the 'End Site' keyword. The end site information ends the recursion and indicates that the current segment is an end effector (has no children). The end site definition gives the length of the preceding segment just like the offset of a child defines the length and direction of its parents segment. The world space is defined as a right handed coordinate system with the Y axis as the world up vector.

In the default BVH hierarchy, the character is in a T-pose. Use the 3ds Max exporter to write a neutral pose (arms parallel to body). Use the Poser exporter to reduce the number of chest segments from 4 to 2.

The motion section begins with the keyword 'MOTION'. This line is followed by the number of motion frames by the keyword 'Frames' and 'Frame Time', indicating the sampling rate of the data. The rest of the file contains the actual motion data; the X, Y and Z position of the root segment and Euler angles of each segment with respect to its parent segment. Each line is one sample of motion data. The numbers appear in the order of the channel specifications as the skeleton hierarchy was parsed.

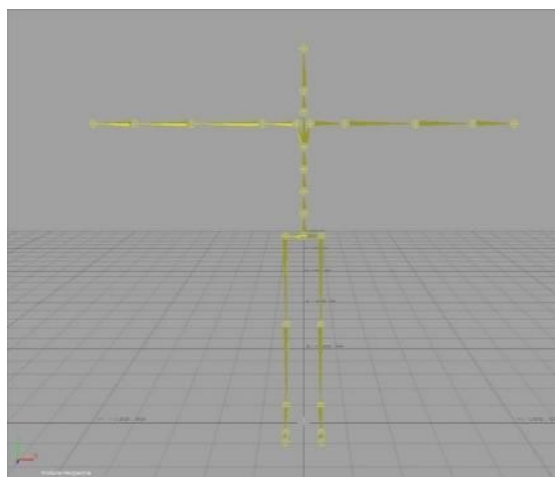
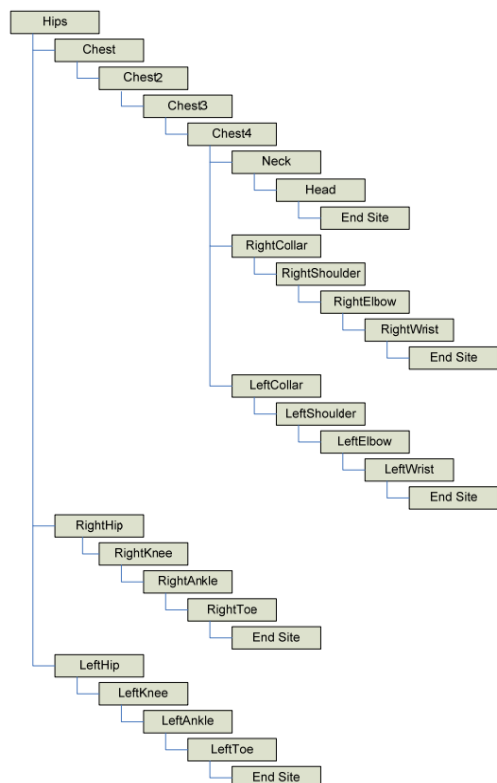

It should be noted that the BVH format is restrictive and it does not reflect the full information as captured with MVN. The numerical resolution of BVH files is limited compared to the MVN and MVNX files. The Euler angle conversion may cause round-off issues in certain poses (singularities). Since all segments are rigidly connected (which is

not the case in the MVN Fusion Engine) some foot slide may occur since all errors such as mainly soft tissue artefacts are 'projected' on the feet. Further optimization can be done by using inversed kinematics (IK) solvers which are usually available in animation applications and which are also necessary for retargeting the motion data to different characters.

The BVH format does not support multi-person recordings. For each person a separate BVH file will be made.

Set the BVH preferences. An explanation of each option is provided below.

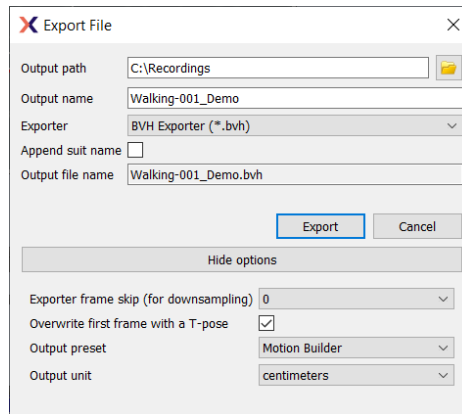

Figure 85: BVH Preferences Menu

### 15.1.1 Frame skip

The frame skip number (n) is used to reduce the frame rate of the output. The exporter will perform down sampling by skipping every n frames (n = 0 to 10) of the original file (after smoothing) in the output. Note that if no smoothing is specified, no smoothing will be applied when using frame skip.

The output rate is given by: original sample rate / (1 + skip factor).

**For example, an MVN file recorded at 100 Hz:**

frame skip = 1, output frame rate = 50 Hz  
frame skip = 2, output frame rate = 33 Hz  
frame skip = 3, output frame rate = 25 Hz

**Or for example, an MVN file recorded at 240 Hz:**

frame skip = 1, output frame rate = 120 Hz  
frame skip = 2, output frame rate = 80 Hz  
frame skip = 3, output frame rate = 60 Hz

So, take care when selecting your preferred motion capture update rate if you need a specific output frame rate, it can make your life easier.

### 15.1.2 Overwrite first frame with T-pose

To align the captured motion data with an animation model, the T-pose will actually be inserted before the first frame of the data. The position and orientation of all segments can be found in the MVNX file in the <tpose>section.

### 15.1.3 Output Presets

Several Output Presets are available that fit specific applications:

- Motion Builder
- 3D Studio Max
- Poser 6

### 15.1.4 Output Unit

Select the desired output unit that is used in the animation program.

## 15.2 C3D

C3D means “Coordinate 3D”; as the name suggests it is a file format designed to contain 3D coordinate data, usually in the form of bony landmarks. It has also been designed to contain analog data. The 3D and analog samples are interleaved, frame-by-frame, throughout the data in a straightforward manner.

C3D data can contain 3D, 2D, analog data or a combination. The menu in Figure 86 shows the possibilities allowed for C3D export.

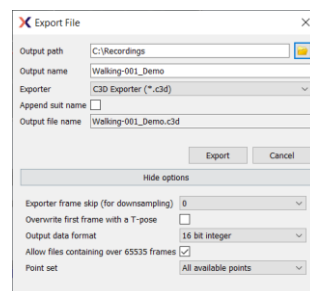

Figure 86: C3D Exporter interface in Preferences menu

There are two lists of points that can be exported, “All available points” and “External Points”. External Points are included in the “All available” selection. Section 15.2.1 is a list of the anatomical landmarks exported by C3D. Just like BVH, C3D data can be downsampled prior to exporting.

Most systems accept the 16 bit integer output format. However, when this is not the case, the single precision floating point (IEEE 754) can be chosen, which will enhance resolution (less output quantization).

In the past C3D was designed to accept no more than 65535 frames. Tick the box to allow trials longer than 65535.

A prop will be exported in C3D with tags: ‘origin’, ‘tip’ and ‘extra’.



### 15.2.1 Points exported in C3D Exporter

For an illustration of the location of the points, see Figure 93.

#	points	#	points
1	pHipOrigin	33	pRightTopOfHand
2	pRightASI	34	pRightPinky
3	pLeftASI	35	pRightBallHand
4	pRightCSI	36	pLeftTopOfHand
5	pLeftCSI	37	pLeftPinky
6	pRightIschialTub	38	pLeftBallHand
7	pLeftIschialTub	39	pRightGreaterTrochanter
8	pSacrum	40	pRightKneeLatEpicondyle
9	pL5SpinalProcess	41	pRightKneeMedEpicondyle
10	pL3SpinalProcess	42	pRightMiddleKneeCap (or pRightPatella)
11	pT12SpinalProcess	43	pLeftGreaterTrochanter
12	pPX	44	pLeftKneeLatEpicondyle
13	pIJ	45	pLeftKneeMedEpicondyle
14	pT4SpinalProcess	46	pLeftMiddleKneeCap (or pLeftPatella)
15	pT8SpinalProcess	47	pRightLatMalleolus
16	pC7SpinalProcess	48	pRightMedMalleolus
17	pTopOfHead	49	pRightTibialTub
18	pRightAuricularis	50	pLeftLatMalleolus
19	pLeftAuricularis	51	pLeftMedMalleolus
20	pBackOfHead	52	pLeftTibialTub
21	pRightAcromion	53	pRightHeelFoot
22	pLeftAcromion	54	pRightFirstMetatarsal
23	pRightArmLatEpicondyle	55	pRightFifthMetatarsal
24	pRightArmMedEpicondyle	56	pRightPivotFoot
25	pLeftArmLatEpicondyle	57	pRightHeelCenter
26	pLeftArmMedEpicondyle	58	pRightToe
27	pRightUlnarStyloid	59	pLeftHeelFoot
28	pRightRadialStyloid	60	pLeftFirstMetatarsal
29	pRightOlecranon	61	pLeftFifthMetatarsal
30	pLeftUlnarStyloid	62	pLeftPivotFoot
31	pLeftRadialStyloid	63	pLeftHeelCenter
32	pLeftOlecranon	64	pLeftToe

If props have been used in the measurement, these will also be exported in the C3D file. The parameters of the props are Extra, Origin and Tip. If more than one prop has been used, the label will be appended with “\_” and the number of the prop (2 onwards). To use the point, as with the output points of the biomechanical model, use the label “Origin”. Tip and Extra are needed to calculate the orientation of the prop.

### 15.3 FBX

FBX (Filmbox) is a platform-independent 3D file format which gives you access to content authored in software packages such as MotionBuilder, Maya, Unity or Softimage. For some software packages, an FBX plug-in should be installed.

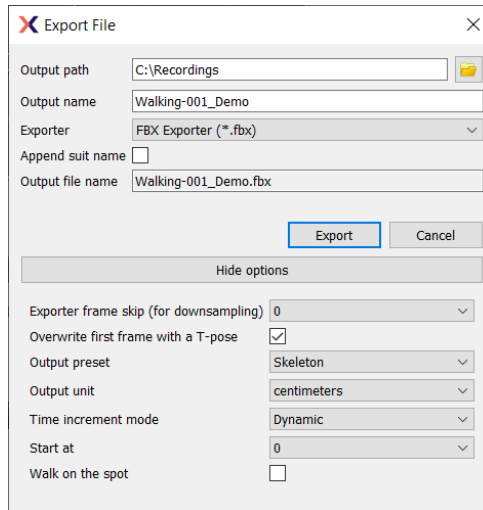

Figure 87: FBX Preferences Menu

FBX files contain both position and orientation information of all 23 segments. The FBX file will also contain the frame time format. Go to >Options >Preferences >Exporters >FBX ... and select the timestamp output mode. To store the appropriate time code in an FBX file, the FBX exporter plug-in must be set to "Dynamic time increments" and "Start at real start time" as seen in

Figure 87. This figure also shows that many of the options for FBX are also applicable to BVH. For details, see the above descriptions for the items on the BVH menu.

Under Output preset you have the option to choose "Default" and "Skeleton". "Default" export contains position and orientation information of all 23 segments in global coordinates. "Skeleton" export contains skeleton hierarchy information in a way that is used by many common 3D software packages like MotionBuilder, Maya, Unity and Houdini.

## 15.4 MVNX

MVNX (MVN Open XML format) files are provided. These are XML files that can be opened in programs such as Microsoft Excel, Access, MATLAB and C-Motion Visual 3D.

C-Motion Visual 3D fully supports MVNX data, an example video of the integration can be found here: <https://www.youtube.com/watch?v=btGLIStuqd4>

Tutorial videos are available on how to import MVNX data into, respectively, Microsoft Excel and MATLAB:

<https://tutorial.xsens.com/video/importing-mvnx-into-excel>

<https://tutorial.xsens.com/video/importing-mvnx-into-matlab>

MVNX contains as default, 3D segment and position data.

Additional values can be exported as Figure 88 shows, including:

- 3D Position, linear and angular acceleration and velocity of all 23 segments.
- 3D Joint angles of 22 joints.
- Center of Mass position of the body
- Contact data indicating which contact point was detected as ground contact
- 3D Orientation, free acceleration and magnetic field data of all 17 MT's.

Since MVN 4.0, a time code field is also available.

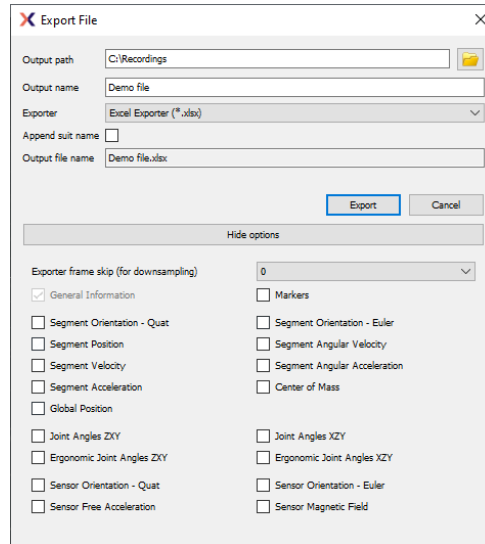

Figure 88: MVNX Preferences Menu

The MVN Fusion Engine calculates the position and orientation, and other kinematic data of each body segment,  $B$ , with respect to an earth-fixed reference co-ordinate system,  $G$ . By default, the earth-fixed reference co-ordinate system used is defined as a right handed Cartesian co-ordinate system.

The axes of the Global reference system are defined as:

- X (red) pointing to the local magnetic North.
- Y (green) according to right-handed coordinate system (West)
- Z (blue) pointing up

The axes of each body frame ( $B$ ) are aligned with this Global reference frame ( $G$ ) when the subject is standing in the T-pose as shown in Figure 89.

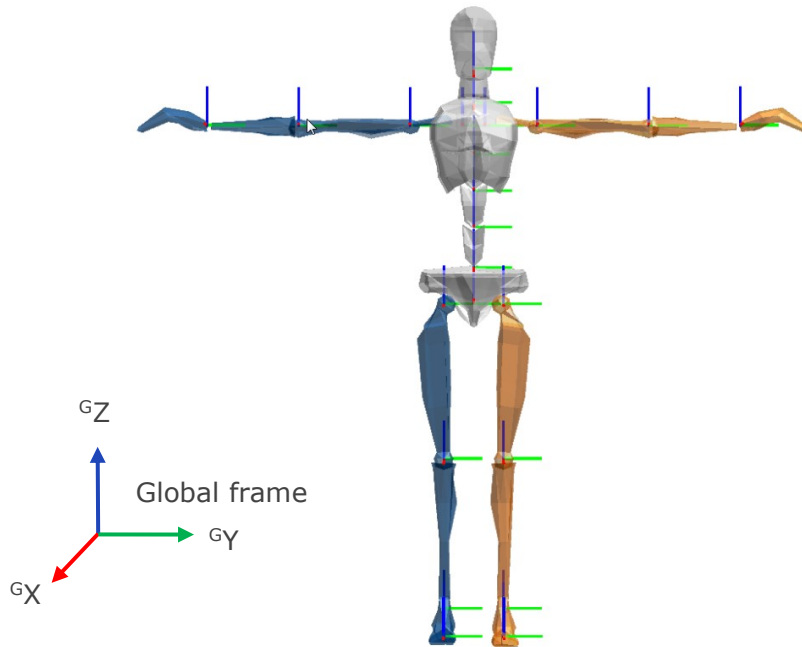

Figure 89: Segment coordinate system at each segment origin, as is used in MVN. Legend:  $x$ : red,  $y$ : green,  $z$ : blue

This section describes the MVNX definition based on version 4 (available since MVN 4.3.7). This version contains some important fixes with respect to the previous version and it is recommended to use this version. Still, version 3 is available and can be chosen in the MVNX exporter preferences. Section 15.4.1 contains more details on the differences between MVNX version 3 and version 4.

The entire MVNX structure is as follows:

```
<?xml version="1.0" encoding=" UTF-8"?>
<mvnx version="4">
  <mvn version="..." build="..." />
  <comment></comment>
  <subject label="Suit..." frameRate="..." segmentCount="..." recDate="..." originalFilename="...">
    <comment></comment>
    <segments>
      <segment label="..." id="...">
        <points>
          <point label="...">
            <pos_b>X Y Z</pos_b/>
          </point>
        </points>
      </segment>
    </segments>
    <sensors>
      <sensor label="..." />
    </sensors>
    <joints>
      <joint label="...">
        <connector1>...</connector1>
        <connector2>...</connector2>
      </joint>
    </joints>
    <frames segmentCount="..." sensorCount="..." jointCount="...">
      <frame time="..." index="..." type="normal">
        <orientation>GBqseg1 GBqseg2 ...etc... GBqseg23</orientation>
        <position>Gposseg1 Gposseg1 ...etc... Gposseg23</position>
        <velocity>Gvseg1 Gvseg2 ...etc... Gvseg23</velocity>
        <acceleration>Gaseg1 Gaseg2 ...etc... Gaseg23</acceleration>
        <angularVelocity>Gwseg1 Gwseg2 ...etc... Gwseg23</ angularVelocity >
        <angularAcceleration>Gawseg1 Gawseg2 ...etc... Gawseg23</angularAcceleration>
        <footContacts> LeftFoot_Heel ... LeftFoot_Toe ... RightFoot_Heel ... RightFoot_Toe </footContacts>
        <sensorMagneticField>Smsen1 Smsen2 ...etc... Smsen17</sensorMagneticField>
        <sensorOrientation>GSqsen1 GSqsen2 ...etc... GSqsen17</sensorOrientation>
        <jointAngle>jjnt1 jjnt2 ...etc... jjnt22</jointAngle>
        <jointAngleXZY>Jjnt1 Jjnt2 ...etc... Jjnt22</jointAngleXZY>
        <jointAngleErgo> JEjnt1 JEjnt2 ...etc... JEjnt4 </jointAngleErgo>
        <centerOfMass>GCseg1 GCseg2 ...etc... GCseg23 </centerOfMass>
        <marker>"name" </ marker >
      </frame>
    </frames>
  </subject>
  <securityCode code="..." />
</mvnx>
```

The MVNX file starts with the XML version. Then the root element "mvnx" with a reference to the XSD (XML Schema Definition) and the MVNX version. This is followed by a field "mvn", containing the MVN Analyze/Animate version and build details with which this MVNX file was produced, followed by the comments that were added to the original recording:

```
<?xml version="1.0" encoding=" UTF-8"?>
<mvnx xmlns:xsi="http://www.w3.org/2001/XMLSchema-instance"
xmlns="http://www.xsens.com/mvn/mvnx" xsi:schemaLocation="http://www.xsens.com/mvn/mvnx
http://www.xsens.com/mvn/mvnx/schema.xsd version="4">
  <mvn version="..." build="..." />
  <comment></comment>
```

The file continues with session information, including the suit label (= name of the MVN System), sample frequency used, number of segments calculated (indicating full or half

body); the date that the recording took place, and the filename of the original recording on which the MVNX file is based. When creating a recorded file, a user can insert a comment. This is available in the exported MVNX: (this field usually has the same contents as the comment field after the <mvn> tag, see above)

```
<subject label="Suit 00130268" frameRate="100 segmentCount="23" recDate="day month
year" originalFilename="DIRECTORY\FILENAME.mvn">
<comment></comment>
```

The next section contains mesh scale and labeling information for the segments. The mesh scale data is used for scaling of the visualization of the character in MVN Analyze/Animate.

The section <segments> defines all positions (pos\_b) of connecting joints (prefixed with a "j") and anatomical landmarks (prefixed with a "p") with respect to origin of that segment (in body frame *B*). The body frame (*B*) of this list of points is defined by Figure 89.

Within each segment is:

```
<segments>
<segment label="RightUpperLeg" id="16">
  <points>
    <point label="...">
      <pos_b>X Y Z</pos_b/>
    </point>
  etc.
  </points>
</segment>
```

The sensor data is simply a list of the names of segments measured with the MT's:

```
<sensors>
  < sensor label = "Pelvis"/>
  < sensor label = "Head"/>
  < sensor label = "RightShoulder"/>
  etc.
</sensors>
```

The "joints" section is a list of the names of joints contained and the segments and connections a given joint:

```
<joints>
  <joint label=" jLeftHip">
    <connector1>Pelvis/jLeftHip </connector1>
    <connector2>LeftUpperLeg/jLeftHip </connector2>
  </joint>
  etc.
</joints>
```

The “ergonomic joint angles” section is a list of specific joint angles used in ergonomic analysis contained, and the segments and connections for each given joint:

```
<ergonomicJointAngles>
  <ergonomicJointAngle label=" T8_Head" index="0" parentSegment="T8" childSegment="Head"/>
  etc.
</ergonomicJointAngles>
```

The “foot contact definition” section is a list of the given foot contact points, and their index in the foot contact definition array for every given time frame, if the point is in contact with the ground, it is given the value 1, whilst if it is not in contact, given the value 0:

```
<footContactDefinition>
  <contactDefinition label="LeftFoot_Heel" index="0"/>
  etc.
</footContactDefinition>
```

The frames section is opened with the segment, sensor and joint count. The data of all parameters are contained within this section, including the calibration pose data.

```
<frames segmentCount= "... " sensorCount= "... " jointCount= "... ">
  <frame ... >
  </frame>
  Etc.
</frames>
```

The frame type “identity” denotes the nullpose or identity pose. All segment orientations in this pose are aligned with the global coordinates and have unit quaternion.

```
<frame time="0" type="identity">
  <orientation>...</orientation/>
  <position>...</position/>
</frame>
```

The frame type “tpose” describes the positions and orientations of all segments in the T-pose. The positions and orientations of certain segments deviates slightly from the identity pose.

```
<frame time="0" type="tpose">
  <orientation>...</orientation/>
  <position>...</position/>
</frame>
```

The frame type “tpose-isb” describes the positions and orientations of all segments in the T-pose, but using the MVN anatomical frame for the body segments (Figure 92). The MVN anatomical frame is used to calculate the joint angles.

```
<frame time="0" type="tpose-isb">
  <orientation>...</orientation/>
  <position>...</position/>
</frame>
```

Following this, the frames are split into *time*; each frame increment is equivalent to  $([\text{frame no.} / \text{update rate}] * 1000 \text{ [ms]})$ . So at 120Hz, frame 1 is denoted by  $([1/120] * 1000) = 8.3[\text{ms}]$ . Frames measured during a normal session are denoted with *type* = “normal”.

The *index* attribute still contains the original frame number.

The optional “tc” and “ms” attributes contain the TimeCode values, i.e. the absolute real time at which that specific frame was recorded (often used to synchronize and combine this recording with other data that was gathered at the same time).

The selection in the preferences menu determines the MVNX contents. Orientation and Position are mandatory, all others are optional and may depend on the license.

```
<frame time= "... " index="frame number" tc="15:57:47:02" ms="1418227067039" type="normal">
<orientation>GBqseg1GBqseg2 ...etc... GBqseg23</orientation>
<position>Gposseg1Gposseg2 ...etc... Gposseg23</position>
<velocity>Gvseg1Gvseg2 ...etc... Gvseg23</velocity>
<acceleration>Gaseg1Gaseg2 ...etc... Gaseg23</acceleration>
<angularVelocity>Gwseg1Gwseg2 ...etc... Gwseg23</ angularVelocity >
<angularAcceleration>Gawseg1Gawseg2 ...etc... Gawseg23</angularAcceleration>
<footContacts> LeftFoot_Heel ... LeftFoot_Toe ... RightFoot_Heel ... RightFoot_Toe </footContacts>
<sensorMagneticField>Smsen1Smsen2 ...etc... Smsen17</sensorMagneticField>
<sensorOrientation>GSqsen1GSqsen2 ...etc... GSqsen17</sensorOrientation>
<jointAngle>jjnt1jjnt2 ...etc... jjnt22</jointAngle>
<jointAngleXZY>Jjntx1Jjntx2 ...etc... Jjntx22</jointAngleXZY>
<jointAngleErgo>JEjnt1JEjnt2 ...etc... JEjnt4</jointAngleErgo>
<centerOfMass>GCseg1GCseg2 ...etc... GCseg23</centerOfMass>
<marker>"name" </ marker name>
</frame>
```

For the elements represented below with a subscript "seg", the set will contain the number of segments (segmentCount) times the number of columns of data. For a full body, this is 23 segments.

Subscript "sen" contains the number of MT's (sensorCount) times the number of columns of data. For a full body, this is 17.

Subscript "jnt" contains the number of joints (jointCount) times the number of columns of data. For a full body, this is 22 joints.

Function	Description
<sup>G<sup>B</sup>q<sub>seg</sub></sup>	1x4 quaternion vector (q <sub>0</sub> , q <sub>1</sub> , q <sub>2</sub> , q <sub>3</sub> ) describing the orientation of the segment with respect to the global frame.
<sup>G<sup>pos</sup><sub>seg</sub></sup>	1x3 position vector (x, y, z) of the origin of the segment in the global frame in [m].
<sup>G<sup>v</sup><sub>seg</sub></sup>	1x3 velocity vector (x, y, z) of the origin of the segment in the global frame in [m/s].
<sup>G<sup>a</sup><sub>seg</sub></sup>	1x3 acceleration vector (x, y, z) of the origin of the segment in the global frame in [m/s <sup>2</sup> ].
<sup>G<sup>w</sup><sub>seg</sub></sup>	1x3 angular velocity vector (x, y, z) of the segment in the global frame in [rad/s].
<sup>G<sup>aw</sup><sub>seg</sub></sup>	1x3 angular acceleration vector (x, y, z) of the origin of the segment in the global frame in [rad/s <sup>2</sup> ].
<sup>G<sup>a</sup><sub>sen</sub></sup>	1x3 sensor free acceleration vector (x, y, z) of the sensor in [m/s <sup>2</sup> ].
<sup>S<sup>m</sup><sub>sen</sub></sup>	1x3 sensor magnetic field vector (x, y, z) of the sensor in [a.u.].
<sup>G<sup>S</sup><sub>q<sub>sen</sub></sub></sup>	1x4 sensor orientation quaternion (q <sub>0</sub> , q <sub>1</sub> , q <sub>2</sub> , q <sub>3</sub> ) of the sensor in the global frame in.
<sup>j<sub>jnt</sub></sup>	1x3 Euler representation of the joint angle vector (x, y, z) in [deg], calculated using the Euler sequence ZXY using the ISB based coordinate system.
<sup>J<sub>jntx</sub></sup>	1x3 Euler representation of the joint angle vector (x, y, z) in [deg], calculated using the Euler sequence XZY using the ISB based coordinate system. <b>Note: The joint angle using Euler sequence XZY is calculated and exported for all joints, but commonly only used for the shoulder joints, and it may depend on the movement of the shoulder if it is appropriate to use.</b>
<sup>G<sup>C</sup><sub>seg</sub></sup>	1x3 position of the body Center of Mass (x,y,z) in the global frame in [m].



The numbering is presented in the table below.

Number	Segment Label	Tracker	Joint
1	Pelvis	Pelvis	jL5S1
2	L5	T8	jL4L3
3	L3	Head	jL1T12
4	T12	RightShoulder	jT9T8
5	T8	RightUpperArm	jT1C7
6	Neck	RightForeArm	jC1Head
7	Head	RightHand	jRightC7Shoulder
8	Right Shoulder	LeftShoulder	jRightShoulder
9	Right Upper Arm	LeftUpperArm	jRightElbow
10	Right Forearm	LeftForeArm	jRightWrist
11	Right Hand	LeftHand	jLeftC7Shoulder
12	Left Shoulder	RightUpperLeg	jLeftShoulder
13	Left Upper Arm	RightLowerLeg	jLeftElbow
14	Left Forearm	RightFoot	jLeftWrist
15	Left Hand	LeftUpperLeg	jRightHip
16	Right Upper Leg	LeftLowerLeg	jRightKnee
17	Right Lower Leg	LeftFoot	jRightAnkle
18	Right Foot		jRightBallFoot
19	Right Toe		jLeftHip
20	Left Upper Leg		jLeftKnee
21	Left Lower Leg		jLeftAnkle
22	Left Foot		jLeftBallFoot
23	Left Toe		

#### 15.4.1 MVNX backwards compatibility

Until MVN 4.3.7, MVNX (version 3) contained some inconsistencies related to the coordinate frames, which have been resolved (version 4). For backwards compatibility, it is still possible to import and export version 3 of MVNX.

The changes of version 4 with respect to version 3 are:

- The list of points at the beginning of the MVNX files is now correctly denoted as `pos_b` instead of `pos_s`.
- The segment orientations  ${}^G B q$  give the relation between global frame ( $G$ ) and body frame ( $B$ ). In version 3, this body frame is defined in Figure 89 and consistently used in the MVNX. In version 3, the body frames are defined by the MVN anatomical pose (Figure 92).
- The initial poses used by the MVNX are now written as "identity" denoting the null-pose, "tpose" denoting the T-pose, and "tpose-isb" denoting the T-pose using the MVN anatomical coordinate frame. In version 3, the initial poses were "tpose"

denoting the T-pose using MVN anatomical coordinate frame, and “npose” denoting the relation between the body frames of the T-pose and MVN anatomical pose.

## 15.5 Export Movie

Exporting movie data enables the user to export the 3D viewport of MVN Analyze/Animate to either .m4v or .avi. this facilitates presenting MVN information to audiences without the need for installation of MVN Analyze/Animate, Select the export format, resolution and export frame in >Options >Preferences >Exporters >Movie Exporter.

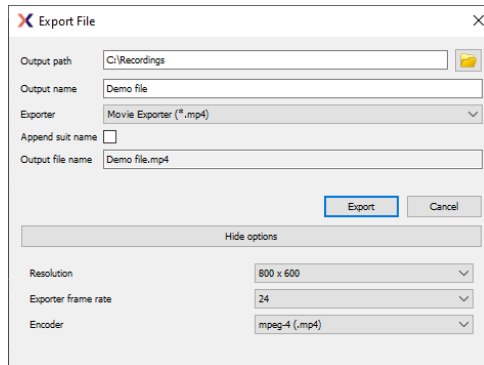

## 15.6 Export Excel

It is now possible to export your data into an excel spreadsheet, simply put the output path, and file name in. Under Exporter select "Excel Exporter (\*.xlsx)". And click Export.

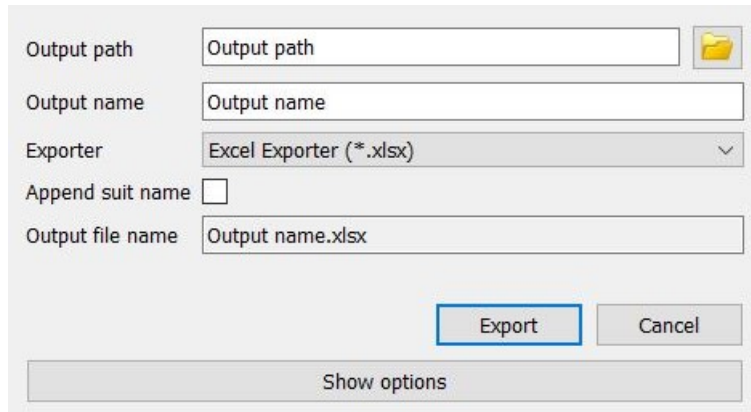

The screenshot shows a dialog box for exporting data to an Excel spreadsheet. It contains the following fields and controls:

- Output path:** A text input field containing "Output path" with a folder icon to its right.
- Output name:** A text input field containing "Output name".
- Exporter:** A dropdown menu currently set to "Excel Exporter (\*.xlsx)".
- Append suit name:** An unchecked checkbox.
- Output file name:** A text input field containing "Output name.xlsx".
- Buttons:** "Export" and "Cancel" buttons are located at the bottom right. The "Export" button is highlighted with a blue border.
- Show options:** A button at the bottom center.

Each corresponding section of the navigator (ie. Segments, joints etc.) will have its own tab in the xlsx file, each joint/segment will have its own column, with the frames listed in the rows.

## 16 Features of MVN SW licenses

A range of additional features become available when using another license for MVN system. Additionally, the MVN Animate and MVN Analyze software has been restructured into:

- Basic: free to download software, to create MVN files
- Plus: stream to your third party software
- Pro: all features included

See the full comparison of the different Basic, Plus and Pro licenses below.

Features for Animate: <https://www.xsens.com/compare/mvn-animate>

Features for Analyze: <https://www.xsens.com/compare/analyze-basic>

### 16.1 MVN usage statistics

An additional feature of MVN Analyze/Animate is the ability to gather and send anonymous usage statistics. The purpose of this is to help inform Xsens which components and features are most frequently used. Moreover, it can guide product management in making decisions to improve the product, inform quality assurance on which features to test, as well as the development team to ensure changes/fixes have had the desired effect. The data is anonymous via random identification and sent to Xsens once per day, with no personal data being stored. The user has the option to opt out of these statistics within the splash screen when MVN is first opened, as well as in the preferences section of the option tab.

## 17 MVN Ethernet Camera

MVN Analyze/Animate has the ability to record synchronized MVN and video data. This is possible using the Ethernet camera (Prosilica GS650) provided with the PRO system. The camera is a high quality professional GigE camera with a C mount. The GigE interface enables the use of long cables (max 100m) and standard 1 Gigabit Ethernet cards for interfacing. The currently supported frame rate in MVN Analyze/Animate is limited, but the camera itself is capable of 120 frames per second (fps), depending on lighting conditions. The camera has a global shutter and is capable of advanced triggering and synchronization features.

<https://base.xsens.com/hc/en-us/articles/360012884940-MVN-Ethernet-Camera-Legacy->

**Note: The MVN Ethernet Camera is a legacy product. If you are looking for similar functionality, the Remote App for iOS and Android might be suited (13. MVN Remote app for iOS and Android)**

## 18 Xsens Peripheral Software

### 18.1 Magnetic Field Mapper (MFM)

When a motion tracker is mounted to an object that contains ferromagnetic materials, the measured (Earth) magnetic field can become distorted, causing errors in measured orientation. To correct for known magnetic disturbances, for example, an MT attached to a steel prosthesis or prop, or simply that the magnetic field has become distorted due to an event or over time, a separate software product has been developed to allow users to remap the magnetic field. This software is called Magnetic Field Mapper (MFM). If MFM is needed, users should contact [support@xsens.com](mailto:support@xsens.com) for further support.

### 18.2 Firmware Updater

With new software releases, it can be expected that new firmware is required. For this purpose, Xsens supplies a firmware updater which can be downloaded separately from MVN Analyze/Animate at <https://www.xsens.com/software-downloads> under 'Tools and Firmware'.

### 18.3 Software Activation Tool: Offline License Activation or Updating a License

An offline activation can be performed with the Software Activation Tool. In the offline activation process a Customer-to-Vendor (c2v) file is generated containing information on the current status of the licenses in your Sentinel protection keys. You can then send this file in order to activate license or receive a license update.

**Note: If you are using a dongle you must connect the dongle, before performing either of the following procedures.**

#### 18.3.1 Step 1: Retrieve the license information from a Sentinel protection key

1. Launch the Software Activation tool from the start menu or help menu in MVN 2018.x
2. Click "Show advanced options".
3. Activating a Software License key for the first time: ensure that "Installation of a New Protection Key" is selected at the bottom of the screen. Updating an existing key or activate a dongle: ensure that "Update of existing protection key" is selected at the bottom of the screen.
4. Click "Create security key information file (C2V)"
5. Click "Next", the file is generated
6. Specify the directory where you want to store the C2V file. Enter a file name and click "Save".
7. The C2V file for the Sentinel protection key is generated and saved in the required location. The file can now be sent.

#### 18.3.2 Step 2: Send the C2V file

1. Send the C2V file to Xsens support ([support@xsens.com](mailto:support@xsens.com)) requesting an offline license file.
2. You will receive a Vendor-to-Customer file (v2c) from Xsens support.

#### 18.3.3 Step 3: Apply the received v2c file using the Software Activation tool.

1. Launch the Software Activation tool.
2. Click "Show advanced options".
3. Click "Apply license file (V2C)".

4. Click "Next" and browse to the V2C files you have received to open it  
The license is activated/updated.

### *18.4 Software Activation Tool: Applying an Update*

You can use the Software Activation tool to apply an update to the licenses stored in your Sentinel protection keys.

To update the licenses in the Sentinel protection keys:

1. Launch the Software Activation tool from the start menu or help menu in MVN Analyze/Animate
2. Click "Show advanced options".
3. Click "Apply license file (V2C)".
4. Click "Next" and browse to the V2C files you have received to open it  
The license is activated/updated.

### *18.5 RUS Utility: Rehosting a Sentinel protection key*

The RUS utility can be downloaded from: <https://www.xsens.com/software/>

You can use the RUS utility to transfer a Sentinel protection key from one computer (the source computer) to another (the recipient computer). This is a three-step procedure that uses the RUS utility on both computers.

#### 18.5.1 Step 1: Collect Information about the Recipient Computer

1. On the recipient computer, launch the RUS utility
2. Click the Transfer License tab.
3. Follow the instructions labelled "Step 1" to collect information about the computer and save it to a file. Make sure that the file (or a copy of the file) is accessible on the source computer.

#### 18.5.2 Step 2: Generate the License Transfer File

1. On the source computer, launch the RUS utility
2. Click the Transfer License tab.
3. Follow the instructions labelled "Step 2" to select the SL key to transfer, read the recipient information file, and generate a license transfer (h2h) file. Make sure that the license transfer file (or a copy of the file) is accessible on the recipient computer.

**Note: After you perform this step, the SL key is no longer available on the source computer. Be sure to keep a copy of the transfer file until you have completed the transfer procedure.**

#### 18.5.3 Step 3: Apply the License Transfer File

1. On the recipient computer, in the RUS utility, click the Apply License File tab.
2. In the Update File field, click the browse button and locate the license transfer (h2h) file.
3. Click Apply Update. The SL key is installed on the recipient computer.

**Note: To ensure the success of the transfer procedure, all the steps in the procedure should be completed within no more than a two days of the time you first start the process.**

### *18.6 Setup a network license*

The server that will carry the licenses needs to be setup.

<https://base.xsens.com/hc/en-us/articles/360012575799-How-to-set-up-a-Server-and-Client-for-Network-License>

How to activate a network license:





<https://base.xsens.com/hc/en-us/articles/360012632119-How-to-activate-a-Network-License>

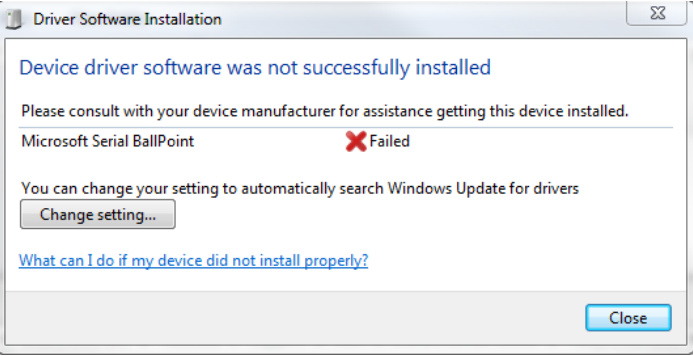

## 19 Troubleshoot

Problem	Solution
<p>Device driver error Awinda Station with docked MTw's results in "Driver Software Installation" error. See figure to the right displaying the pop-up warning:</p>	 <p>This is a timing issue because Xsens motion trackers send data to the PC continuously to guarantee a fast set up time. To solve, remove the tracker from the station then redock.</p>
<p>The suit does not connect.</p>	<p>Check battery levels.</p> <p>Check 'Hardware status' menu (Section 7.6).</p> <p>Check Suit configuration (Section 7.2.5)</p> <p>Ensure that only one MVN Analyze/Animate is running on a given computer.</p> <p>MVN LINK: Turn on the BP off and on again (Section 5.1.2.1).</p> <p>Run a WPS between BP and AP</p> <p>MVN Awinda: Unplug Awinda Station from power supply and PC then reconnect re-plug.</p> <p>Power off MTws press power button for 6s. Press for 1s to turn back on.</p>
<p>MTx status remains missing ('red') in 'Hardware status' menu</p>	<p>Check if MTx is connected. Sometimes a connector can become loose after putting on the suit.</p> <p>Replace MTx and relocate sensor ID (Section 7.6.1).</p>
<p>MVN Analyze/Animate does not start (Shader compilation / validation errors).</p>	<p>Use a computer with at least a DirectX 9 hardware card.</p>
<p>Limited range wireless connection</p>	<p>Turn off all other wireless equipment (Bluetooth, WiFi, etc) and scan for a WiFi channel free of other wireless signals.</p>
<p>Live preview is active but recording is not possible</p>	<p>Enter the subject dimensions: body height and Foot or Shoe length (Section 7.2.9).</p> <p>Perform an N-pose + Walk calibration (Section 8.1). Make sure to apply.</p> <p>MVN Awinda: Make sure that no Synchronization settings have been saved to the Awinda station</p>

Character sticks to the ground or segments are pulled apart (wrongly detected contacts).	<p>Enter correct body dimensions of subject (Section 7.2.9).</p> <p>Perform new calibration pose.</p> <p>Choose suitable user scenario (default is flat ground assumption) (Section 7.2.6).</p> <p>Make sure the feet trackers are mounted rigidly.</p>
Character appears to bounce slightly when no movement is taking place.	<p>This is likely to be caused by visualization rather than data issues. Can result when tile size on the floor in MVN Analyze/Animate is large.</p> <p>Verify that the character is not moving using position data (eg graphical representation) to ensure that no movement is being detected. The position data should remain unchanged.</p> <p>When this is the case, make the tile size smaller, usually 50cm is a good tile size for visualization. To do this, go to &gt;Options &gt;Preferences &gt;Interface &gt; 3D View</p>
Shadows have jerky movements, even when character remains unmoving.	<p>Visualization issue, probably caused by floor tile size being too large, meaning that the shadow is redrawn too frequently. Decrease the size of the tiles to reduce this visualization effect.</p>
Pelvis is displayed too high.	<p>MVN file is recorded with old version of MVN Analyze/Animate. Make a copy of the original file and reprocess (Section 10.5.2.6).</p>
The system does not run in real-time.	<p>Close all other running application.</p> <p>Check wireless connection (maximum range and disable other wireless equipment).</p> <p>Reduce the display frame rate and/or update rate.</p> <p>See Section 23.12 for the specification of the recommended computer system.</p>
During recording, the rotations of some segments do not correspond with the 3D character.	<p>Check if MT's have not moved in the suit. Perform a new calibration.</p> <p>Move calmly for 10-20 seconds directly after calibration.</p> <p>Stand still and perform a Character Reset (Ctrl+Alt+F).</p>
During recording, the rotations of some segments are not smooth.	<p>Check wireless connection.</p> <p>Sensors clipped. Use 'Correct sensor clipping data on reprocess' option in &gt;Options &gt;Preferences &gt;General &gt;Recordings. Reprocess file.</p> <p>Stand still and perform a Character Reset (Ctrl+Alt+F).</p> <p>With MVN Awinda: Change the radio channel (See 23.11.1) Verify that this is also the case with a saved and reprocessed file (which will also contain retransmitted data)</p>
Graphical performance of MVN Analyze/Animate is poor; update of image is slow	<p>Set display frame rate to the same rate as the update rate in the preferences menu.</p>
Avatar/ system drops from MVN Analyze/Animate	<p>This may be due to network configurations. Uninstall the network driver for the active Ethernet connection (through your device manager) then reinstall.</p>

 <p>With MVN Awinda there appears to be a large latency</p>	<p>Change the radio channel. (See 23.11.1)</p>
 <p>MTw LED shows dual blink pattern</p>	<p>This does not happen often, if it does it means that the MTw has crashed. To restore to normal, switch it off, by pressing the button for 6s. Press it for 1s to turn it back on.</p>
 <p>When connecting 2 or more MVN Awinda systems, MTw's assign to the wrong awinda station</p>	<p>Begin by connecting one Awinda station and turn on the MTw's for the system associated with this receiver. Select the system under Accepted Systems and change the Wifi Radio channel in the Hardware Status window to allow all of the MTw's to connect.</p> <p>Once the system is detected, repeat this process with the second and additional systems.</p>
 <p>Character walks in place or is seen flying across the screen</p>	<p>Check to make sure that all trackers are in the correct locations</p>
 <p>The battery from one MTw tracker drains much faster than the other trackers</p>	<p>Contact support <a href="http://base.xsens.com">base.xsens.com</a> for assistance.</p>

## 20 Warranty and liability

Xsens Technologies B.V. warrants the products manufactured by it to be free from defects in material and workmanship for a period of 2 years from the date of delivery. Products not subjected to misuse will be repaired, replaced or credit issued at the sole option of Xsens Technologies B.V. Contact support: [base.xsens.com](https://base.xsens.com) for return material authorization (RMA) prior to returning any items for calibration, repair or exchange. The product **must be returned in its original packaging** to prevent damage during shipping.

The warranty shall not apply to products repaired or altered or removed from the original casing by others than Xsens Technologies B.V. so as, in Xsens Technologies B.V. opinion, to have adversely affected the product, products subjected to negligence, accidents or damaged by circumstances beyond Xsens Technologies B.V.'s control.

**Note: Xsens reserves the right to make changes in its products in order to improve design, performance, or reliability.**

Subject to the conditions and limitations on liability stated herein, Xsens warrants that the Product as so delivered shall materially conform to Xsens' then current specifications for the Product, for a period of one year from the date of delivery. ANY LIABILITY OF XSSENS WITH RESPECT TO THE SYSTEM OR THE PERFORMANCE THEREOF UNDER ANY WARRANTY, NEGLIGENCE, STRICT LIABILITY OR OTHER THEORY WILL BE LIMITED EXCLUSIVELY TO PRODUCT REPAIR, REPLACEMENT OR, IF REPLACEMENT IS INADEQUATE AS A REMEDY OR, IN XSSENS' OPINION IMPRACTICAL, TO REFUND THE PRICE PAID FOR THE PRODUCT. XSSENS DOES NOT WARRANT, GUARANTEE, OR MAKE ANY REPRESENTATIONS REGARDING THE USE, OR THE RESULTS OF THE USE, OF THE PRODUCT OR WRITTEN MATERIALS IN TERMS OF CORRECTNESS, ACCURACY, RELIABILITY, OR OTHERWISE. Xsens shall have no liability for delays or failures beyond its reasonable control.

### 20.1 Customer Support

Xsens Technologies B.V. is glad to help you with any questions you may have about MVN or about the use of the technology for your application. Please contact Xsens Customer Support:

- ➔ by our forum: [base.xsens.com/](https://base.xsens.com/)
- ➔ telephone: Xsens HQ +31 88 97367 00 / Xsens US office 310-481-1800

To be able to help you, please mention the 8-digit number on the Xsens Sticker, you can find this at the handle of the Suitcase or backpack.

## 21 Regulatory Notices MVN Link

### 21.1 Radio Frequency Exposure and Emission

The MVN Link system contains a small radio transmitter and receiver. During communication with other Wi-Fi products system receives and transmits radio frequency (RF) electromagnetic fields (microwaves) in the frequency range 2400 to 2500 MHz or 5200 to 5700MHz. The output power of the radio transmitter is very low. When using the system, you will be exposed to some of the transmitted RF energy. This exposure is well below the prescribed limits in all national and international RF safety standards and regulations.

Most modern electronic equipment, for example, in hospitals and cars, is shielded from RF energy. However, certain electronic equipment is not.

Therefore:

**Note: This equipment emits RF energy in the ISM (Industrial, Scientific, Medical) band. Please insure that all medical devices used in proximity to this device meet appropriate susceptibility specifications for this type of RF energy.**

Turn off this electronic device before entering an area with potentially explosive atmosphere. It is very rare, but any electronic device could generate sparks. Sparks in such areas could cause an explosion or fire resulting in bodily injury or even death. Areas with a potentially explosive atmosphere are often, but not always, clearly marked. They include fuelling areas, such as petrol station, below deck on boats, fuel or chemical transfer or storage facilities, and areas where the air contains chemicals or particles, such as grain, dust, or metal powders.

## 21.2 CE Declaration of Conformity MVN Link

### EU Declaration of Conformity

Applicable objects:  
MVN Link

Manufacturer:  
Xsens Technologies B.V.  
Pantheon 6a  
7521 PR ENSCHEDE  
THE NETHERLANDS

This declaration of conformity is issued under the sole responsibility of the manufacturer.  
The objects of the declaration described above are in conformity with the relevant Union harmonization legislation, based on the tested mode of operation(s), the applicable performance criteria, and specified acceptance criteria:

Short name	Directive
Radio Equipment Directive (RED)	2014/53/EU
Electromagnetic compatibility (EMC)	2014/30/EU
Low Voltage Directive (Product Safety)	2006/95/EC
Restriction of the use of certain hazardous substances (RoHS)	2011/65/EU

Relevant harmonized standards used:

Standard description	Standard	Result
Emission	EN 301 489-01 V2.1.1 & EN 301 489-03 V1.6.1 & EN 301 489-17 V3.1.1, Class B	Pass
Immunity	EN 301 489-01 V2.1.1 & EN 301 489-03 V1.6.1 & EN 301 489-17 V3.1.1, Industrial	Pass
Radiated emission up to 1 GHz (SAC)	EN 55032 (2015) + AC (2016)	Pass
ESD	EN-IEC 61000-4-2 (2009)	Pass
Radiated Immunity	EN-IEC 61000-4-3 (2006) + A1 (2008) + A2 (2010)	Pass
Power Frequency Magnetic field	EN-IEC 61000-4-8 (2010)	Pass
Product Safety	EN-IEC 62368-1:2014 + AC:2015 + A11:2017 + AC:2017	Pass

The following test report is subject to this declaration:

Test report number:

20200724RPT01.pdf  
20C00095RPT02.pdf

Issue date: 2020 November, 18  
Issue date: 2021 March, 1

Signed for and on behalf of:  
Enschede 2021 March, 18

Igor Ikink, Director Technology

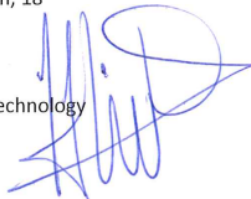

## 21.3 Certificate of Conformity for Radio Equipment in EU

To whom it may concern,

Hereby, u-blox AG declares under its sole responsibility that the following product – JODY-W1 Host-based multiradio modules – comply with the essential requirements and other relevant provisions of Radio Equipment Directive (RED) 2014/53/EU and with the Directive 2011/65/EU (EU RoHS 2) and its amendment Directive (EU) 2015/863 (EU RoHS 3).

Technology	Product name	Hardware release	Software release
Wi-Fi and Bluetooth	JODY-W164-03A	01 or later	
	JODY-W164-04A	00 or later	
	JODY-W164-05A	00 or later	
	JODY-W164-13A	00 or later	PCIe Driver/Firmware Release P8.1 or later
	JODY-W164-15A	00 or later	
	JODY-W167-00A	00 or later	
	JODY-W167-03A	00 or later	
	JODY-W167-00B	00 or later	
	JODY-W164-07A	01 or later	SDIO Driver/ Firmware Release S5.1 or later
	JODY-W164-27A	00 or later	
	JODY-W163-04A	00 or later	
	JODY-W163-05A	00 or later	
JODY-W163-13A	00 or later		

Essential requirements	Standards
<b>Radio Equipment Directive 2014/53/EU</b>	
<b>Safety &amp; Health</b> (Article 3.1a)	EN 62368-1 :2014+A11 :2017 EN 62311:2008 (Wi-Fi) EN 62479:2010 (Bluetooth + Bluetooth Low Energy)
<b>EMC</b> (Article 3.1b)	EN 301 489-1 V2.1.1 EN 301 489-17 V3.1.1
<b>Radio Spectrum Efficiency</b> (Article 3.2)	EN 300 328 V2.2.2 EN 301 893 V2.1.1 EN 300 440 V2.1.1
<b>Essential requirements</b> <b>Directive 2011/65/EU (EU RoHS 2)</b> <b>Directive 2015/863 (EU RoHS 3)</b>	
<b>Prevention</b> (Article 4.1)	EN 50581:2012

Authorized representative within the European Union:  
u-blox AG, Zürcherstrasse 68, 8800 Thalwil, Switzerland

Name	Alberto Sampino
Position	Senior Manager Quality/Environmental System & Supplier Quality
Date of issue	14 May 2020
Signature	

### List of antennas

Antenna name	Manufacturer	Comment	Gain	
			2.4 GHz	5 GHz
-	-	Assumed gain (No external antennas tested. Radiated tests were performed with 50 Ω termination at the antenna ports.)	0	0

## 21.4 FCC Statement

**Note:** This equipment has been tested and found to comply with the limits for a Class B digital device, pursuant to Part 15 of the FCC Rules. These limits are designed to provide reasonable protection against harmful interference in a residential installation. This equipment generates, uses and can radiate radio frequency energy and, if not installed and used in accordance with the instructions, may cause harmful interference to radio communications. However, there is no guarantee that interference will not occur in a particular installation. If this equipment does cause harmful interference to radio or television reception, which can be determined by turning the equipment off and on, the user is encouraged to try to correct the interference by one or more of the following measures:

1. Reorient or relocate the receiving antenna
2. Increase the separation between the equipment and receiver
3. Connect the equipment into an outlet on a circuit different from that to which the receiver is connected

Consult the dealer or an experienced radio/TV technician for help

<p>This device contains <b>FCC ID:</b> XPYJODYW164 <b>IC:</b> 8595A-JODYW164</p>
--



## 21.5 FCC Declaration of Conformity MVN Link

### FCC Declaration of Conformity

Applicable objects:  
MVN Link

Manufacturer:  
Xsens Technologies B.V.  
Pantheon 6a  
7521 PR ENSCHEDE  
THE NETHERLANDS

The objects of the declaration described above is in conformity with the relevant FCC regulations, based on the tested mode of operation(s), the applicable performance criteria, and specified acceptance criteria

Object classification	Directive
Computers and other digital devices, unintentional radiator	47 CFR 15

Relevant standards used:

Test description	Standard	Result
Emission	47 CFR 15 & ICES-003, class B	Pass
Radiated emission up to 1 GHz (SAC)	ANSI C63.4 (2014)	Pass

Operation is subject to the following two conditions:

- (1) this device may not cause harmful interference, and
- (2) this device must accept any interference received, including interference that may cause undesired operation.

The following test report is subject to this declaration:

Test report number: 20200725RPT01.pdf Issue date: 2020 November, 18

The following manufacturer/importer/entity is responsible for this declaration:

Company name: Xsens Technologies B.V.  
Name Title: Igor Ikin, Director Technology  
Address: Pantheon 6a, 7521 PR ENSCHEDE, THE NETHERLANDS  
Phone: +31 (0)889736700  
Fax: +31 (0)889736701

Signed for and on behalf of:  
Enschede 2021 March, 18

Igor Ikin, Director Technology



## 21.6 Certificate of Conformity for Radio Equipment in Japan

telefication bv  
The Netherlands  
Chamber of Commerce  
5165536  
www.telefication.com



### Certificate of Radio Equipment in JAPAN

No: 201-200064 / 00

Telefication, operating as Conformity Assessment Body (CAB ID Number: 201) with respect to Japan, declares that the listed product complies with the Technical Regulations Conformity Certification of Specified Radio equipment (ordinance of MPT N° 37.1981)

Product description: **Multiradio modules with dual band Wi-Fi**  
Trademark: **Xsens**  
Type designation: **JODY-163-13A**

Manufacturer: **Xsens Technologies B.V.**  
Address: **Pantheon 6a**  
City: **7521 PR ENSCHEDE**  
Country: **Netherlands**

This certificate is granted to:

Name: **Xsens Technologies B.V.**  
Address: **Pantheon 6a**  
City: **7521 PR ENSCHEDE**  
Country: **Netherlands**

This certificate has THREE Annexes.

Zevenaar, 16 September 2020

CAB

A handwritten signature in blue ink that reads "George".

George Chen  
Manager Taiwan



laboratory

certification

approvals

5GHz product for indoor use only using frequencies within 5.15-5.35GHz.  
The product may be used indoor and/or outdoor using frequencies within 5.47-5.72 GHz.

## 22 Regulatory Notices MVN Awinda

### 22.1 Radio Frequency Exposure and Emission

The MTw2, Awinda dongle and station contains a small radio transmitter and receiver. During communication with the Awinda Master it receives and transmits radio frequency (RF) electromagnetic fields (microwaves) in the frequency range 2400 of 2500 MHz. The output power of the radio transmitter is very low. When using the system, you will be exposed to some of the transmitted RF energy. This exposure is well below the prescribed limits in all national and international RF safety standards and regulations. Most modern electronic equipment, for example, in hospitals and cars, is shielded from RF energy. However, certain electronic equipment is not. Therefore:

**Note: This equipment emits RF energy in the ISM (Industrial, Scientific and Medical) band. Please insure that all medical devices used in proximity to this device meet appropriate susceptibility specifications for this type of RF energy (CE or FCC marked).**

Turn off this electronic device before entering an area with potentially explosive atmosphere. It is very rare, but any electronic device could generate sparks. Sparks in such areas could cause an explosion or fire resulting in bodily injury or even death. Areas with a potentially explosive atmosphere are often, but not always, clearly marked. They include fuelling areas, such as petrol station, below deck on boats, fuel or chemical transfer or storage facilities, and areas where the air contains chemicals or particles, such as grain, dust, or metal powders.

## 22.2 CE Declaration of Conformity MTw2, Awinda Station, Awinda Dongle

RF\_061, Issue 04



**XSENS**

### EC Declaration of Conformity

Hereby,

Name of manufacturer: Xsens Technologies B.V.  
Address: Pantheon 6a  
City: Enschede  
Country: The Netherlands

declares that this equipment:

Product description: Wireless Motiontracker system  
Type designation(s): MTW2-3A7G6, AW-A2, AW-DNG2  
Trademark: MVN Awinda

is in compliance with the essential requirements and other relevant provisions of Directive  
1999 / 5 / EC

with reference to the following standards:

EN 300 440-2 V1.4.1  
EN 301 489-1 V1.9.2  
EN 301 489-17 V2.2.1  
EN 60950-1: 2010

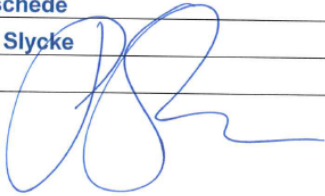
Date: May 27, 2015  
City: Enschede  
Name: Per Slycke  
Signature: 

### 22.3 FCC Statements

This equipment has been tested and found to comply with the limits for a Class B digital device, pursuant to Part 15 of the FCC Rules. These limits are designed to provide reasonable protection against harmful interference in a residential installation. This equipment generates, uses and can radiate radio frequency energy and, if not installed and used in accordance with the instructions, may cause harmful interference to radio communications. However, there is no guarantee that interference will not occur in a particular installation. If this equipment does cause harmful interference to radio or television reception, which can be determined by turning the equipment off and on, the user is encouraged to try to correct the interference by one of the following measures:

- Reorient or relocate the receiving antenna.
- Increase the separation between the equipment and receiver.
- Connect the equipment into an outlet on a circuit different from that to which the receiver is connected.
- Consult the dealer or an experienced radio/TV technician for help.

FCC Caution: Any changes or modifications not expressly approved by the party responsible for compliance could void the user's authority to operate this equipment. This device complies with Part 15 of the FCC Rules. Operation is subject to the following two conditions: (1) This device may not cause harmful interference, and (2) this device must accept any interference received, including interference that may cause undesired operation.

#### **Radiation Exposure Statement for Awinda Station:**

This equipment complies with FCC radiation exposure limits set forth for an uncontrolled environment. This equipment should be installed and operated with minimum distance 20cm between the radiator & your body. This transmitter must not be co-located or operating in conjunction with any other antenna or transmitter.

This MVN Awinda product contains

**FCC ID:** MTw2: QILMTW2-3A7G6  
Awinda Station: QILAW-A2  
Awinda Dongle: QILAW-DNG2  
Awinda Dongle ANT: QILAW-DNG2-ANT

## 22.4 FCC Declaration of Conformity MTw2

# DECLARATION OF CONFORMITY (DoC)

Equipment: **Wireless Awinda Sensor**  
Trademark(s) and Model(s): **MVN Awinda MTW2-3A7G6**  
Manufacturer: **Xsens Technologies B.V.**  
FCC ID in case other parts of this equipment are subject to certification: **QILMTW2-3A7G6**

**This device complies with Part 15 of the FCC Rules.**

**Operation is subject to the following two conditions:**

- (1) this device may not cause harmful interference, and**
- (2) this device must accept any interference received, including interference that may cause undesired operation.**

The following test reports are subject to this declaration:

Test report number: **20153144305 Ver 1.00** Issue date: **6/8/2015**

The following manufacturer/importer/entity is responsible for this declaration:

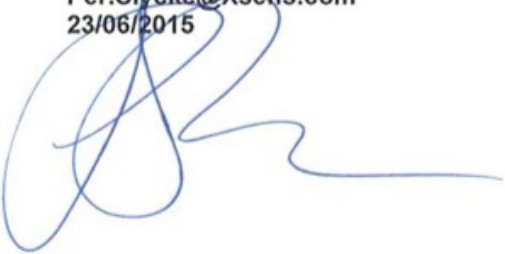
Company name: **Xsens Technologies B.V.**  
Name/Title: **Per Slycke CTO**  
Address: **Pantheon 6a, 7521 PR Enschede, The Netherlands**  
Phone: **+31(0)889736700**  
Fax: **+31(0)889736701**  
E-mail: **Per.Slycke@Xsens.com**  
Date: **23/06/2015**  
Signature: 

## 22.5 FCC Declaration of Conformity Awinda Station

# DECLARATION OF CONFORMITY (DoC)

Equipment: **Wireless Awinda Station**  
Trademark(s) and Model(s): **MVN Awinda AW-A2**  
Manufacturer: **Xsens Technologies B.V.**  
FCC ID in case other parts of this equipment are subject to certification: **QILAW-A2**

**This device complies with Part 15 of the FCC Rules.**

**Operation is subject to the following two conditions:**

- (1) this device may not cause harmful interference, and**
- (2) this device must accept any interference received, including interference that may cause undesired operation.**

The following test reports are subject to this declaration:

Test report number: **20153144303 Ver 1.00** Issue date: **6/8/2015**

The following manufacturer/importer/entity is responsible for this declaration:

Company name:	Xsens Technologies B.V.
Name/Title:	Per Slycke CTO
Address:	Pantheon 6a, 7521 PR Enschede, The Netherlands
Phone:	+31(0)889736700
Fax:	+31(0)889736701
E-mail:	Per.Slycke@Xsens.com
Date:	23/06/2015
Signature:	

## 22.6 FCC Declaration of Conformity Awinda Dongle

### DECLARATION OF CONFORMITY (DoC)

Equipment: **Wireless Awinda Dongle**  
Trademark(s) and Model(s): **MVN Awinda AW-DNG2**  
Manufacturer: **Xsens Technologies B.V.**  
FCC ID in case other parts of this equipment are subject to certification: **QILAW-DNG2**

**This device complies with Part 15 of the FCC Rules.**

**Operation is subject to the following two conditions:**

- (1) this device may not cause harmful interference, and**
- (2) this device must accept any interference received, including interference that may cause undesired operation.**

The following test reports are subject to this declaration:

Test report number: **20153144304 Ver 1.00** Issue date: **6/8/2015**

The following manufacturer/importer/entity is responsible for this declaration:

Company name: **Xsens Technologies B.V.**  
Name/Title: **Per Slycke CTO**  
Address: **Pantheon 6a, 7521 PR Enschede, The Netherlands**  
Phone: **+31(0)889736700**  
Fax: **+31(0)889736701**  
E-mail: **Per.Slycke@Xsens.com**  
Date: **23/06/2015**  
Signature:





## 22.7 Certificate of Radio Equipment in Japan MTw2

telefication bv  
The Netherlands  
Chamber of Commerce  
51565536  
www.telefication.com



# Certificate Of Radio Equipment in JAPAN

No.: 152150087/AA/00

Telefication, operating as Conformity Assessment Body (CAB ID Number: 201) with respect to Japan, declares that the listed product complies with the Technical Regulations Conformity Certification of Specified Radio equipment (ordinance of MPT N° 37,1981)

Product description: **Wireless Awinda Sensor**  
Trademark: **MVN Awinda**  
Family name: --  
Type designation: **MTW2-3A7G6**  
Serial No: --  
Hard-|Software release No: **MW111415|3.0.6**

Manufacturer: **Xsens Technologies B.V.**  
Address: **Pantheon 6a**  
City: **7521 PR Enschede**  
Country: **Netherlands**

This certificate is granted to:

Name: **Xsens Technologies B.V.**  
Address: **Pantheon 6a**  
City: **7521 PR Enschede**  
Country: **Netherlands**

This certificate has THREE Annexes.

Zevenaar, 23 September 2015

A handwritten signature in blue ink, appearing to read "i.o. Jong".

W.J.M. Jong  
Manager Product Certification



**CAB**

laboratory

certification

approvals

## 22.8 Certificate of Radio Equipment in Japan Awinda Station

telefication bv  
The Netherlands  
Chamber of Commerce  
5156536  
www.telefication.com



# Certificate Of Radio Equipment in JAPAN

No.: 152150085/AA/00

Telefication, operating as Conformity Assessment Body (CAB ID Number: 201) with respect to Japan, declares that the listed product complies with the Technical Regulations Conformity Certification of Specified Radio equipment (ordinance of MPT N° 37,1981)

Product description: **Wireless Awinda Station**  
Trademark: **See annex 3**  
Family name: --  
Type designation: **See annex 3**  
Serial No: **See annex 3**  
Hard-/Software release No: **AW140520|3.0.5**

Manufacturer: **Xsens Technologies B.V.**  
Address: **Pantheon 6a**  
City: **7521 PR Enschede**  
Country: **Netherlands**

This certificate is granted to:

Name: **Xsens Technologies B.V.**  
Address: **Pantheon 6a**  
City: **7521 PR Enschede**  
Country: **Netherlands**

This certificate has THREE Annexes.

Zevenaar, 23 September 2015

*W.J.M. Jong*

W.J.M. Jong  
Manager Product Certification



**CAB**

laboratory

certification

approvals

## 22.9 Certificate of Radio Equipment in Japan Awinda Dongle

telefication by  
The Netherlands  
Chamber of Commerce  
51565536  
www.telefication.com



# Certificate Of Radio Equipment in JAPAN

No.: 152150086/AA/00

Telefication, operating as Conformity Assessment Body (CAB ID Number: 201) with respect to Japan, declares that the listed product complies with the Technical Regulations Conformity Certification of Specified Radio equipment (ordinance of MPT N° 37,1981)

Product description: **Wireless Awinda Dongle**  
Trademark: **MVN Awinda**  
Family name: --  
Type designation: **AW-DNG2**  
Serial No: --  
Hard-|Software release No: **AM140520|3.0.5**

Manufacturer: **Xsens Technologies B.V.**  
Address: **Pantheon 6a**  
City: **7521 PR Enschede**  
Country: **Netherlands**

This certificate is granted to:

Name: **Xsens Technologies B.V.**  
Address: **Pantheon 6a**  
City: **7521 PR Enschede**  
Country: **Netherlands**

This certificate has THREE Annexes.

Zevenaar, 23 September 2015

*i.o.*

W.J.M. Jong  
Manager Product Certification



**CAB**

laboratory

certification

approvals

## 23 Appendices

### 23.1 Lycra suit sizes overview

The typical height and weight of a subject that will fit into a given suit size is related. While this is generally accurate, it is an indication, therefore test the suit size, to ensure that it is tight enough to keep MTx's in place during measurement while remaining relatively comfortable.

Size	Body height		Weight	
S	155 - 165 cm	5'1" - 5'4" ft.	50 - 65 kg	110 - 143 lbs.
M	165 - 170 cm	5'4" - 5'6" ft.	65 - 75 kg	143 - 165 lbs.
L	170 - 180 cm	5'6" - 5'9" ft.	75 - 85 kg	165 - 187 lbs.
XL	180 - 195 cm	5'9" - 6'4" ft.	85 - 95 kg	187 - 210 lbs.
XXL	195 - 205 cm	6'4" - 6'8" ft.	95 - 105 kg	210 - 231 lbs.
XXXXL	205 - 215 cm	6'8" - 7'1" ft.	105 - 115 kg	231 - 254 lbs.

### 23.2 MVN kinematics and output

#### 23.2.1 Quaternion orientation representation

A unit quaternion vector can be interpreted to represent a rotation about a unit vector  $\mathbf{n}$  through an angle  $\alpha$ .

$${}^{GB}q = \left( \cos\left(\frac{\alpha}{2}\right), \mathbf{n} \sin\left(\frac{\alpha}{2}\right) \right)$$

A unit quaternion itself has unit magnitude, and can be written in the following vector format:

$$q = (q_0, q_1, q_2, q_3)$$

$$\|q\| = 1$$

Quaternions are an efficient, non-singular description of 3D orientation and a quaternion is unique up to sign:

$$q = -q$$

An alternative representation of a quaternion is as a vector with a complex part, the real component is the first element  $q_0$ .

The inverse  ${}^{BG}q$  is defined by the complex conjugate  $*$  of  ${}^{GB}q$ :

$${}^{GB}q^* = (q_0, -q_1, -q_2, -q_3) = {}^{BG}q$$

As defined here,  ${}^{GB}q$  rotates a vector  ${}^B\mathbf{x}$  in the body co-ordinate system ( $B$ ) to the global reference co-ordinate system ( $G$ ).

$${}^G\mathbf{x} = {}^{GB}q \otimes {}^B\mathbf{x} \otimes {}^{GB}q^* = {}^{GB}q \otimes {}^B\mathbf{x} \otimes {}^{BG}q$$

Where  $\otimes$  represents a quaternion multiplication:

$$q1 \otimes q2 = (q1_0 \cdot q2_0 - v1 \cdot v2, q1_0 \cdot v2 + q2_0 \cdot v1 + v1 \times v2)$$

with:

$$v1 = (q1_1, q1_2, q1_3)$$

$$v2 = (q2_1, q2_2, q2_3)$$

and both  $\cdot$  and  $\times$  represent the standard dot and cross product, respectively. Be aware that the order of multiplication is important. Quaternion multiplication is not commutative, meaning:

$$q_1 \otimes q_2 \neq q_2 \otimes q_1$$

### 23.2.2 Conversions

Quaternion to rotation matrix:

$$\mathbf{R} = \begin{bmatrix} q_0^2 + q_1^2 - q_2^2 - q_3^2 & 2q_1q_2 - 2q_0q_3 & 2q_1q_3 + 2q_0q_2 \\ 2q_1q_2 + 2q_0q_3 & q_0^2 - q_1^2 + q_2^2 - q_3^2 & 2q_2q_3 - 2q_0q_1 \\ 2q_1q_3 - 2q_0q_2 & 2q_2q_3 + 2q_0q_1 & q_0^2 - q_1^2 - q_2^2 + q_3^2 \end{bmatrix}$$

$$= \begin{bmatrix} 1 - 2q_2^2 - 2q_3^2 & 2q_1q_2 - 2q_0q_3 & 2q_1q_3 + 2q_0q_2 \\ 2q_1q_2 + 2q_0q_3 & 1 - 2q_1^2 - 2q_3^2 & 2q_2q_3 - 2q_0q_1 \\ 2q_1q_3 - 2q_0q_2 & 2q_2q_3 + 2q_0q_1 & 1 - 2q_1^2 - 2q_2^2 \end{bmatrix}$$

For further information on quaternion operations and rotations, refer to the book: *J.B. Kuipers. Quaternions and Rotation Sequences. Princeton University.*

### 23.3 Body planes

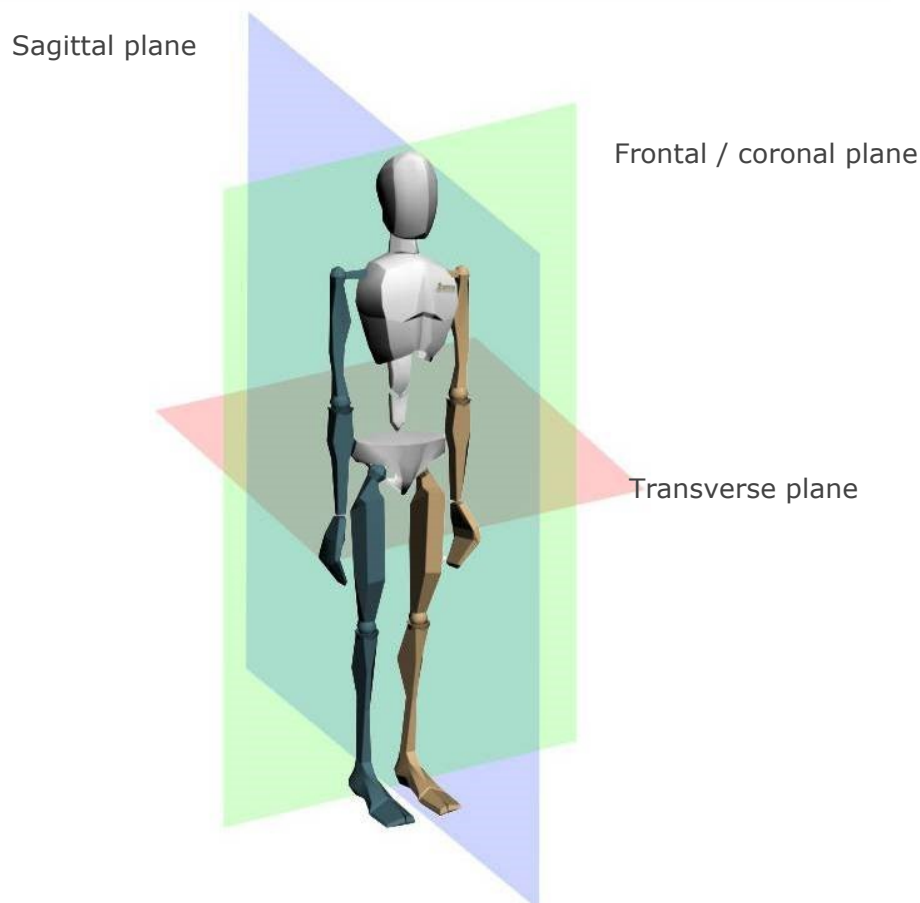

Figure 90: Body planes

## 23.4 Coordinate systems

The MVN Fusion Engine calculates the position and orientation, and other kinematic data of each body segment,  $B$ , with respect to an earth-fixed reference co-ordinate system,  $G$ . By default, the earth-fixed reference co-ordinate system used is defined as a right handed Cartesian co-ordinate system with:

Global reference frame:

- X positive when pointing to the local magnetic North (red).
- Y according to right handed co-ordinates (West) (green).
- Z positive when pointing up (blue).

The body frames are aligned with the Global reference frame when the subject is standing in T-pose. For the calculation of joint angles, an extra frame of reference (based on anatomical pose) is used to define the body frames. This frame of reference defines the body frames by:

- Origin: center of rotation (proximal)
- X forward.
- Y up, from joint to joint.
- Z pointing right.

This different coordinate system is **only** used as in intermediate frame to calculate joint angles. Joint origins are determined by the anatomical frame and are defined in the center of the functional axes with the directions of the X, Y and Z being related to functional movements. For example, flexion/extension of the knee is described by the rotation about the  ${}^B Z$ -axis of the lower leg with respect to the upper leg; abduction/adduction is the rotation about the  ${}^B X$ -axis; and endo/exo rotation is about the  ${}^B Y$ -axis. Note that in some studies, different anatomical and reference frames definitions are used; to compare results proper co-ordinate frame transformations must be performed.

After the calibration procedure, the right heel of the character is set at the origin (0,0,0). This is the begin point of the red arrow in the 3D viewport (pointing in the positive X-direction).

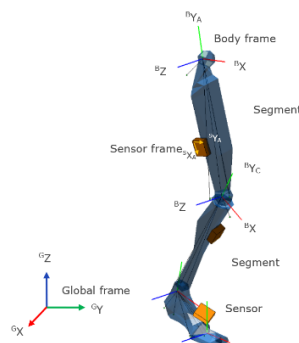

Figure 91: Global and local coordinate frames in MVN Analyze/Animate for the calculation of joint angles

## 23.5 Anatomical model

### 23.5.1 Definition of segment axes

To describe motion capture data in clinically meaningful data, e.g. joint rotations, it is necessary to define a coordinate reference frame attached to the body segment. The ISB proposal for standardization for joint coordinate systems is currently based on positions (optical markers) of bony landmarks. For most segments on the body, the origin of the reference frame and direction of axes are described in Wu and Cavanagh (1995) <sup>[i]</sup> Wu et al. (2002) <sup>[ii]</sup> and Wu et al. (2005) <sup>[iii]</sup>. The MVN Fusion Engine uses the calibration poses to determine the direction of the axes of each segment. Figure 92a shows the origins of the segment axes in the neutral anatomical pose. The origin of the segment is always in the proximal joint center which is the functional rotation point. The origin is chosen such that by connecting all joint centers a character (skeleton) is formed, see Figure 92b. Their positions for the calibration poses in the global reference frame can be found in the <segments>section and <frame type="tpose/tpose-isb"> when exporting as MVNX file.

### 23.5.2 Bony/anatomical landmarks

The positions of bony/anatomical landmarks with respect to the joint origin of the related segment are presented in the MVNX file, see the <points>tag in the <segment>section. Segments are assumed to be rigid bodies.

Positions of anatomical landmarks in the global frame ( $G$ ) can be found by rotating the vector of the landmark in the body frame ( $B$ ) to the global frame and adding the global position of the origin.

$${}^G \mathbf{p}_{landmark} = {}^G \mathbf{p}_{origin} + {}^{GB} \mathbf{q} \otimes {}^B \mathbf{x} \otimes {}^{GB} \mathbf{q}^*$$

Or in rotation matrix formulation:

$${}^G \mathbf{p}_{landmark} = {}^G \mathbf{p}_{origin} + {}^{GB} \mathbf{R} \cdot {}^B \mathbf{x}$$

The rotation from body to global ( ${}^{GB} \mathbf{q}$ ) and global position of the origin ( ${}^G \mathbf{pos}$ ) are given in the MVNX file, see next section.



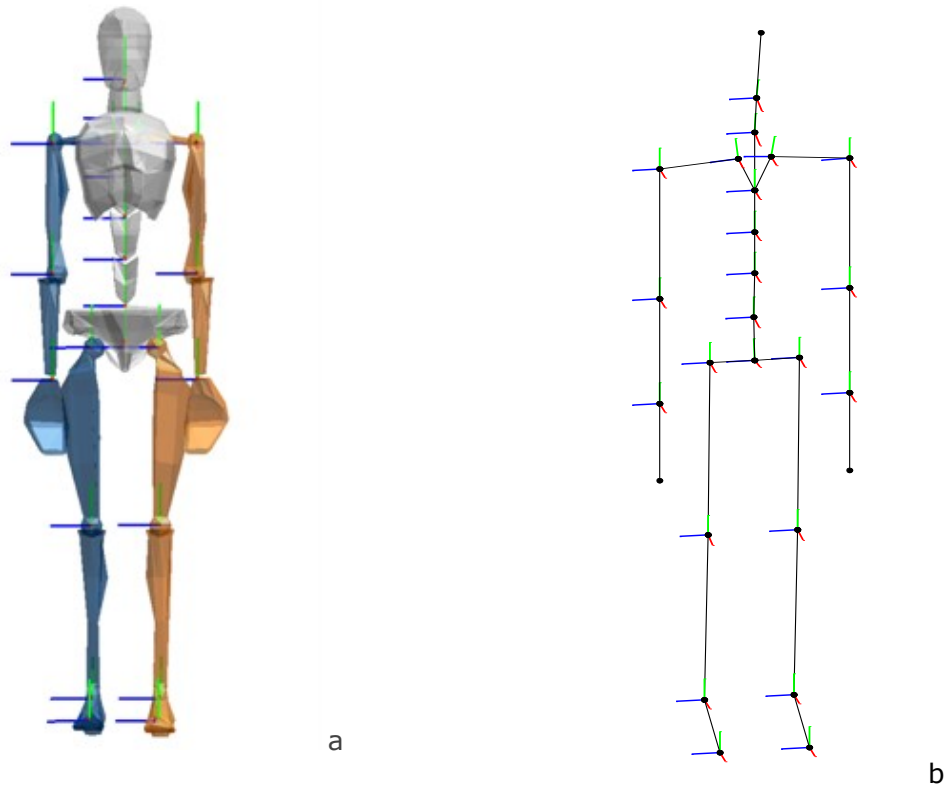
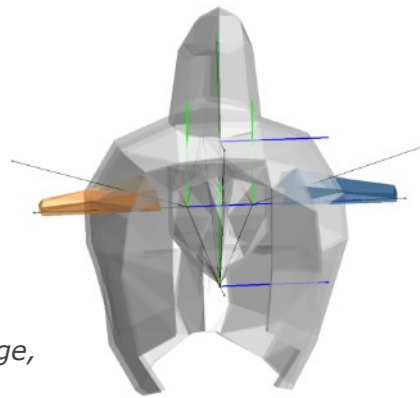
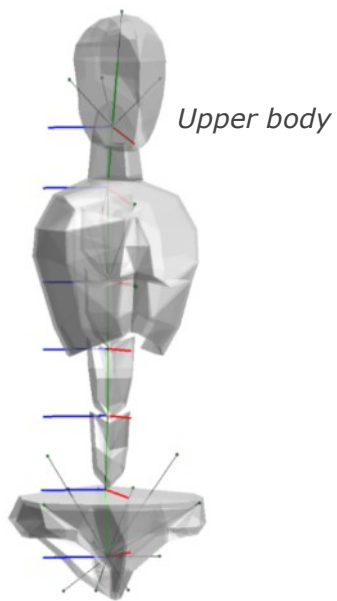

Figure 92: a) Segment coordinate system at each joint origin, as is used in MVN to determine joint angles. b) Joint centers connected, forming a skeleton Legend: x: red, y: green, z: blue

Note that positions of anatomical landmarks are not measured directly as they are with optical measurement systems. They are computed using the measured accelerations, angular velocities and rotations in combination with the biomechanical model. Relevant points are used for the detection of contacts with the external world and as an indication for scaling of segment lengths.

The MVN character mesh (only for visualization) is an abstract representation of the human skeleton; therefore not all anatomical landmarks are exactly on the mesh. The ribcage is connected to T8 and will move accordingly.



T8, ribcage,  
neck and  
shoulders

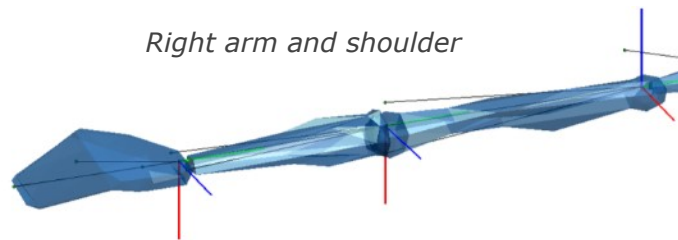

Right arm and shoulder

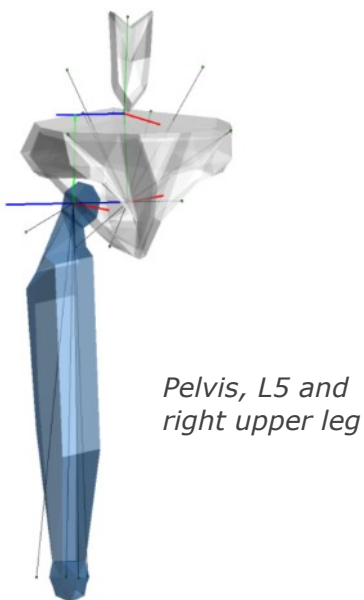

Pelvis, L5 and  
right upper leg

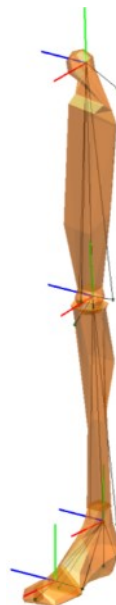

Left leg and  
foot

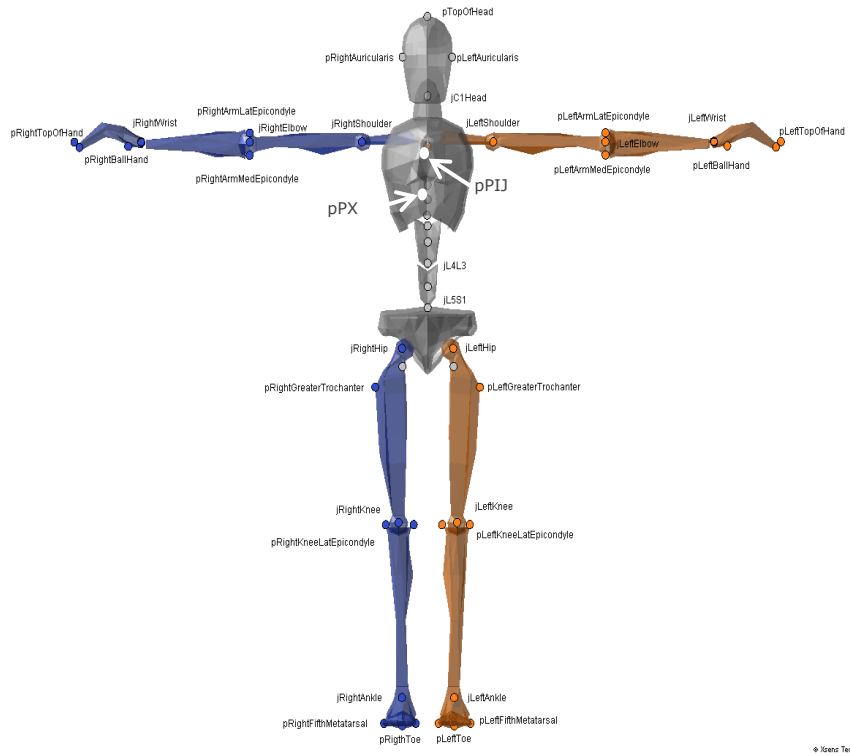
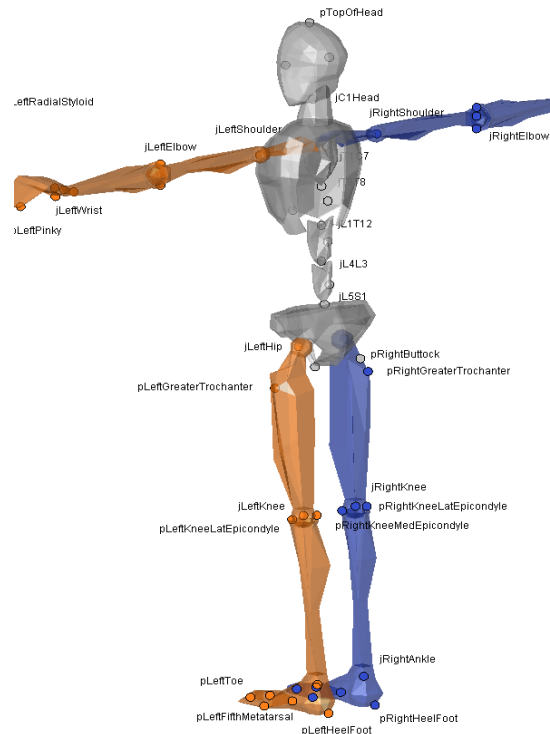

Figure 93: Selection of anatomical landmarks. Above, anterior view. Below, posterior view.



### 23.6 Segment axes definitions and Origin Definitions

Note: To ease comparison between the MVN segment co-ordinate systems with the International Society of Biomechanics recommendation, currently based on optical

position tracking systems, the ISB recommendation is presented next to the MVN definition.

The MVN segment axes definition and origins have been chosen as closely as possible to the ISB recommendation where whenever possible.

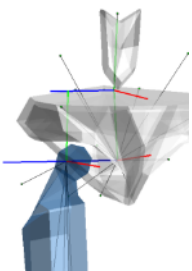
MVN		ISB [ij]	
	O	Midpoint between right and left hip center of rotation	Coincident with hip center of rotation
	X	Perpendicular to Y and Z Pointing forward	Line parallel to a line lying in the plane defined by two ASISs and midpoint of two PSIS, orthogonal to Z-axis. <b>Pointing anteriorly.</b>
	Y	hipOrigin to jL5S1 Pointing up	Line perp. to X and Z. <b>Pointing cranially.</b> (Della Croce et al. <sup>[iv]</sup> )
	Z	to jLeftHip to jRightHip Pointing right	Line parallel to a line connecting right and left ASISs. <b>Pointing right.</b>

NB: Della Croce et al. <sup>[iv]</sup> define O as the midpoint between RASIS and LASIS

### 23.6.1 Spinal segments: L5, L3, T12, T8: Segments 2-5

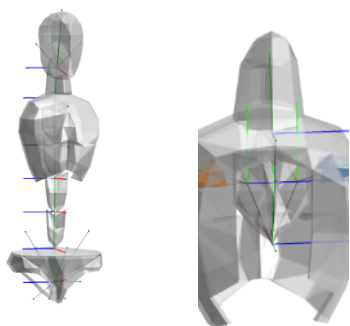
MVN		ISB [ij]	
	O	jL5S1, jL4L3, jL1T12, jT9T8	
	X	Pointing forward	Line per. Y and Z
	Y	Joint to Joint Pointing up	Line passing thru centers of vertebra's upper and lower endplates
	Z	Perp. to X and Y Pointing right	Line parallel to a line joining similar landmarks on the bases and right and left pedicles

**Note: Spine segments not measured directly in MVN, they are interpolated between the MT's of the Pelvis, Sternum and Head using a model of the spine. Joint origins are the rotation points in the vertebrae.**

### 23.6.2 Neck: Segment 6

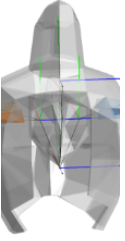
	MVN		ISB
	O	jT1C7	Not described in ISB
	X	Perp. to Y and Z Pointing forward	
	Y	jT1C7 to jC1Head	
	Z	Pointing right	

**Note: The neck segment is not measured directly in MVN; it is calculated using a model of the neck.**

### 23.6.3 Head: Segment 7

	MVN		ISB
	O	jC1Head	Not described in ISB
	X	Perp. to Y and Z	
	Y	jC1Head to TopOfHead	
	Z	Left Ear to Right Ear	

**Note: Position of Ears are not measured but assumed to be on the same height.**

### 23.6.4 Shoulder: Segment 8 Right and Segment 12 Left

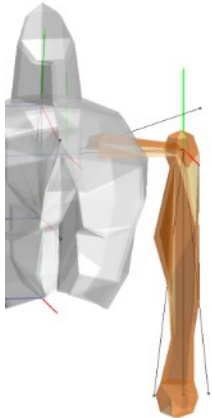
	MVN		ISB
	O	jRightC7Shoulder jLeftC7Shoulder	See Wu et al. [iii] and Šenk et al. v for range of definitions.
	X	Pointing forward	
	Y	Perp. to X and Z	
	Z	<b>Right:</b> jRightC7Shoulder to jRightShoulder to <b>Left:</b> jLeftC7Shoulder to jLeftC7	

In ISB the shoulder complex is described with the Thorax, Clavicle, Scapula and Humerus. MVN does not define the thorax segment. The thorax region is split into spine segments. The mesh of the thorax will move with segment T8 which is measured with the MT of the sternum. MVN does not measure the clavicle and is undefined in MVN.

### 23.6.5 Upper Arm (Humerus): Segment 9 Right and Segment 13 Left

There are two segment coordinate systems described in ISB. The system described below is option 1.

		MVN	ISB [iii]
	O	jRightUpperArm GH jLeftUpperArm GH	GH
	X	Sagittal plane Pointing forward	Line perp. Plane EL-EM-GH Pointing forward
	Y	<b>Right:</b> jRightElbow to jRightShoulder <b>Left:</b> jLeftElbow to jLeftShoulder	Line connecting GH to mid point EL-EM Pointing to GH
	Z	Perp. to X and Y Pointing to the right	Line perp. Y and Z Pointing to the right

### 23.6.6 Forearm (Radius/Ulna): Segment 10 Right and Segment 14 Left

There are two segment coordinate system described in ISB. Option 1 is described here.

		MVN	ISB [iii]
	O	jRightElbow jLeftElbow	US
	X	Pointing forward	Line Perp. plane thru US-RS and midpoint EL-EM Pointing forward
	Y	<b>Right:</b> jRightWrist to jRightElbow <b>Left:</b> jLeftWrist to jLeftElbow	Line connecting GH to mid point EL-EM
	Z	Perp. to X and Y Pointing right	Line perp. X and Y

**Note: The joint origin is the midpoint between the epicondyles in MVN.**

In the anatomical pose, the hand and forearm are orientated forward

### 23.6.7 Hand: Segment 11 Right and Segment 15 Left

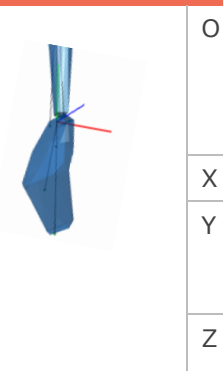
		MVN	ISB [iii]
	O	jRightWrist jLeftWrist	ISB defines origins and axes for each: Of the 5 Metacarpals 14 phalanges
	X	Pointing forward	
	Y	Top of Hand to jRightWrist/jLeftWrist Pointing Vertical	
	Z	Perp. to X and Y Pointing right	

**Note: In MVN, the joint center is the midpoint between the styloids. No metacarpals are measured in MVN.**

This description is for the anatomical pose. When the subject stands in the N-pose, X will no longer point anteriorly, but medially.

### 23.6.8 Upper Leg (Femur): Segment 16 Right and Segment 20 Left

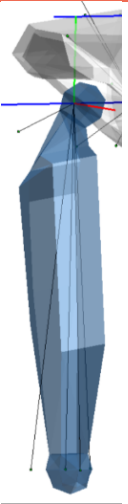
		MVN	ISB [ij]
	O	jRightHip/jLeftHip	(Only defined for use of calculating the hip joint angle): Coincident with right (or left) hip center of rotation, coincident with pelvic center O in neutral configuration
	X	Perpendicular to Y and Z Pointing forward in sagittal plane	Line perp. to Y- and x- <b>Pointing anteriorly.</b> (Della Croce et al. [iv])
	Y	Right: jRightKnee to jRightHip Left: jLeftKnee to jLeftHip	Line joining midpoint between medial and lateral Fes and the origin. <b>Pointing cranially</b>
	Z	Right: Medial to Lateral Left: Lateral to Medial Pointing right	Line perp. to Y-axis lying in plane defined by origin and two Fes. <b>Pointing Right.</b>

**Note: In ISB and MVN, the origin is in center of hip rotation, which is the head of the femur. Della Croce [iv]: midpoint LE and ME. In the MVN model, the lateral and medial epicondyles are on the same height.**

### 23.6.9 Lower Leg (Tibia/Fibula): Segment 17 Right and Segment 21 Left

		MVN	ISB [ii]
	O	jRightKnee jLeftKnee IM	IM
	X	Perp. Y and Z Pointing forwards	Line perp. to torsional plane of tibia/fibula. Pointing anteriorly
	Y	Right: jRightAnkle to jRightKnee Left: jLeftAnkle to jLeftKnee	Line perp. to X and Z
	Z	Right: Medial to Lateral Left: Lateral to Medial Pointing right	Line between MM and LM. <b>Pointing to the right</b>

**Note: In MVN, the joint center is approx. between LC and MC which corresponds with the center of rotation of the lower leg. Same coordinate system as Della Croce [iv], except that the origin is not in IM. In ISB, the Y axis is not along the**

**Tibia. In the MVN model the lateral and medial epicondyles and lateral and medial malleoli are the same height.**

### 23.6.10 Foot (Calcaneus): Segment 18 Right and Segment 22 Left

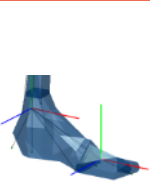
MVN		ISB [ii]
	O	jRightAnkle jLeftAnkle IM
	X	Sagittal plane forward
	Y	Vertical (aligned with gravity, pointing up)
	Z	Perp. to X and Y Pointing right
		IM
		Line perp. to frontal plane of tib/fib in neutral configuration. <b>Pointing anteriorly.</b>
		Line coincident with long axis of tibia/fibula, in neutral configuration. <b>Pointing cranially</b>
		Line perp. to x- and Y-

**Note: In the MVN model lateral and medial malleoli are on the same height.**

### 23.6.11 Toe: Segment 19 Right and Segment 23 Left

The toes are not defined in ISB.

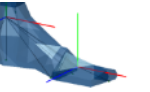
MVN		ISB
	O	jRightToe jLeftToe
	X	Sagittal plane forward
	Y	Vertical (aligned with gravity)
	Z	Perp. to X and Y
		The toes are not defined in ISB.

**Note: In MVN toes are not measured directly but are based on the foot kinematics and contact detection. The origin is between the metatarsals of the foot. Toes can only flex and extend, other kinematics are due to interpolation.**

## 23.7 Joint angles

Typically, a joint rotation is defined as the orientation of a distal segment  ${}^{GB_B}q$  with respect to a proximal segment  ${}^{GB_A}q$  :

$${}^{B_A B_B}q = {}^{GB_A}q^* \otimes {}^{GB_B}q$$

where  $\otimes$  denotes a quaternion multiplication and  $*$  the complex conjugate of the quaternion (see Section 23.2.1). There are a few commonly used parameterizations of the joint rotation  ${}^{B_A B_B}q$  that describe joint angles:

- the Cardan/Euler representation [Cole 1993, Woltring 1994]
- joint coordinate system [Grood & Suntay 1983]<sup>vi</sup>
- helical angle [Kinzel 1972]

Note that all representations of the joint angles are based on the same quaternion or rotation matrix. The differences lie only in how the angles are extracted (represented) from this rotation. The International Society of Biomechanics (ISB) has proposed



standards for rotation sequences for the lower [Wu et al, 2002ii] and upper body [Wu et al 2005iii].

### 23.7.1 Euler Extractions for the joint angles

In order to produce validated joint angle output, Xsens MVN works closely to the ISB and Grood and Suntay recommendations [i,ii,iii,vi]. Almost all angles follow the ISB Euler angle extractions of Z (flexion/extension), X (abduction/adduction) Y (internal/external rotation). The definitions of the origins of the segments are somewhat different, since MVN uses MT's placed on the segment, rather than markers placed on bony landmarks. The origins and coordination axes are defined above.

### 23.7.2 Shoulder angle definitions

For joint angle calculations, the only difference for Euler extractions between MVN and ISB is for the shoulder joint. MVN provides three different shoulder angle calculations, as can be seen in the data tree, after a session has been recorded.

The shoulder joint angles provided are:

- Angles between C7 and the shoulder segment
- Euler rotation sequence ZXY
- Euler rotation sequence XZY

### 23.7.3 Joint angle outputs

Below is an overview of all joints available in MVN and a short description.

Joint Angle	Description (& Euler Sequence)
1	L5S1 Joint between the lumbar spine segment 5 and sacral spine 1 (ZXY)
2	L4L3 Joint between the lumbar spine segment 4 and lumbar spine segment 3 (ZXY)
3	L1T12 Joint between the lumbar spine segment 1 and thoracic spine segment 12 (ZXY)
4	C1Head Joint between the cervical spine segment 1 and the head segment (ZXY)
<b>Left and Right</b>	
5	C7Shoulder Joint between cervical spine 7 and the MVN shoulder segment
6	Shoulder ZXY Shoulder joint angle between the MVN shoulder segment and the upper arm; calculated using the Euler sequence ZXY
7	Shoulder XZY Shoulder joint angle between the MVN shoulder segment and the upper arm; calculated using the Euler sequence XZY
8	Elbow Joint between the upper arm and the forearm. (ZXY)
9	Wrist Joint between the forearm and the hand. (ZXY)
10	Hip Joint between the pelvis and upper leg. (ZXY)
11	Knee Joint between the upper leg and lower leg. (ZXY)
12	Ankle Joint between the lower leg and foot. (ZXY)
13	BallFoot Joint between the foot and the calculated toe. (ZXY)

## 23.8 Xsens motion capture engine

Traditional motion capture systems based on inertial and magnetic sensing typically estimate the position and orientation of each segment by applying the result of a sensor-

to-segment calibration procedure to an estimate of sensor orientation, and applying a (scaled) biomechanical model of the human body. Each of these components will introduce errors, but the most dominant error source are generally the magnetic distortions which are present anywhere (e.g. common materials in buildings, furniture, and surrounding electronic equipment). The typical sensor fusion of inertial and magnetic sensor signals is done by combining the tracking of short-term changes in orientation by the gyroscopes with the accelerometer and magnetometer readings to provide stability for the long-term for inclination and heading respectively. The above mentioned magnetic distortions will affect the heading estimates yielding inconsistent tracking of the motion. Despite the huge improvements in accuracy of orientation tracking over the last years, there are fundamental limits to the accuracy that can be obtained using gyroscopes, accelerometers and magnetometers alone.

In the past years, Xsens has spent tremendous effort towards a new motion capture engine that aims to overcome the major sources of error present in current solutions and to provide an accurate and consistent solution. Contrary to the current MVN system, Xsens MVN Analyze/Animate uses a sophisticated motion capture engine that combines the data of all motion trackers with an advanced biomechanical model to get rid of the effects of magnetic distortions. The engine works well in any environment and a variety of dynamics. This means that measurements can include motions ranging from semi-static to high dynamics.

An important aspect of using any measurement apparatus is the scale of the sensor. Often, for example with a temperature sensor (thermometer!) when the range is exceeded, the sensor either breaks or simply can no longer measure outside of the defined range. With the Xsens sensors and the new engine, this is completely prevented. Clipping (exceeding the dynamic range) is of course possible, but the effect is negligible.

### 23.8.1 Height tracking

Due to the many improvements, from signal processing to how data is handled in MVN Analyze/Animate including foot contact detection, it is now possible to track height changes of a subject e.g. walking upstairs or up a steep slope while wearing the system. Please note that height changes due to e.g. changing floor level in an elevator will not be detected, since there is no relative change in motion of the body segments, in this case, it will appear that the subject stands still and continues on a level plane.

### 23.8.2 Engine settling time

Settling time is the time needed for the engine to “warm up”. After applying the calibration, or when manually reinitializing the motion capture engine (both when standing still), it is recommended to move slowly (e.g. walk round) for about 30 seconds.

## 23.9 Update Rate versus Sample Frequency

Since MVN Studio 4.0, Xsens refers to the term “update rate” rather than sample frequency. This is an intentional change in terminology since the data is sampled in a different way than in the past.

Normal, digital systems using some form of recording relies on sampling of this data. Since data is sampled, this implies some degree of data loss at those time instances that no sampling took place. Sampling must take place a measurable time, some amount of times over a given time frame. This is known as the sampling frequency. Most systems operate at a given sample frequency.

The intentional difference in terminology is needed to highlight that data from new Xsens motion trackers (MTx and MTw) undergoes a mathematical method called Strap Down Integration. This ensures that no loss of accuracy is experienced, even though the data is transmitted to the PC at lower update rates. Update rates as low as 20 or 30Hz still provides very accurate data.

### 23.10 *Strap Down Integration*

Strap down integration (SDI) is a method used to compute an orientation/position change given an angular velocity and linear acceleration of a rigid body. Angular velocity and acceleration data in the MTx and MTw is sampled at a very high frequency (1000Hz) to maintain accuracy under very dynamic conditions such as vibrations and impacts. The sampling frequency is too high to be transmitted wirelessly, and would typically present a computational load that is too high on the receiving host device (e.g. PC). Based on this data, the MTx and MTw calculates velocity increments and orientation increments using the SDI algorithm. The main advantage of using the SDI algorithm is that full 3D tracking accuracy can be maintained even if the output update rate from the MTx and MTw is lower (<100 Hz). An additional advantage is that the MTx and MTw can continue to track the 3D motion internally when facing transient data loss in the RF transmission and immediately report the full 3D velocity and orientation increment as soon as the RF link is restored, without the need to re-transmit all the data that was lost which would a) cause a large delay during real-time tracking b) use a lot of precious RF bandwidth and consume unnecessary power. The specific use of SDI data in combination with such a specialized RF protocol, Xsens has named the Awinda protocol<sup>7</sup>.

### 23.11 *The Awinda Protocol*

The Awinda protocol is the wireless protocol that controls the data stream from the MTws to the Awinda Station or Awinda Dongle. This wireless protocol provides accurate time synchronization of up to 32 MTw's across the wireless network to within 10 microseconds, achieving 'wired like' system performance. The Awinda protocol is developed such that no data is ever lost. If individual packets are missed, there is some room to contain data temporarily. This buffered data is then retransmitted. If these packets become lost (for example if the subject wearing the hardware is outside of the radio transmission range and for a prolonged period – meaning the buffer becomes full) then it is still possible to retrace the missing data due to the use of SDI. Retransmitted data is used during reprocessing, for this reason Awinda data can appear better – smoother and more accurate after reprocessing.

#### 23.11.1 *Choosing a Radio Channel for MVN Awinda*

Figure 94 provides an overview of the allowed channels for operating MVN Awinda. The Awinda protocol is based on the IEEE 802.15.4, around 2.4 GHz. The bottom row of the figure shows the channels on the 2.4GHz, the top row shows how WiFi channels use the spectrum. This should indicate to the user that the best channels to use when you know which channel WiFi is on. When in an environment where WiFi is also expected to be in prevalent use, but you are not sure which channels, try Channels 11, 15, 20 or 25. Bluetooth uses the entire spectrum around 2.4 GHz, but will (try to) avoid channels in use by other systems including Awinda channels.

---

<sup>7</sup> Patents pending.

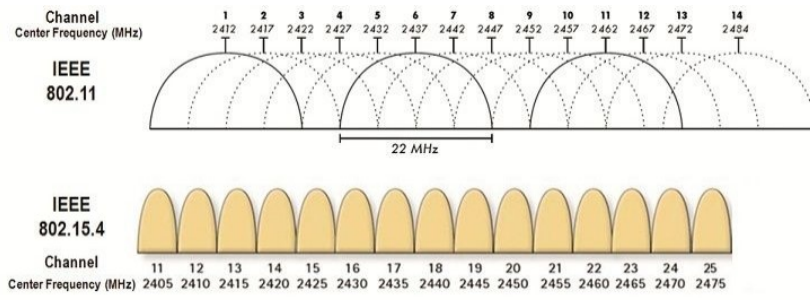

Figure 94: Overview of channels operating around 2.4GHz; for ease of channel selection

## 23.12 System Specifications

Recommended computer system	
Operating system	Windows 10 (64 bit)
Processor	Quad core or higher (2.7 GHz or faster)
Hard drive	SSD 256 GB or more
Memory	8 GB RAM (64-bit)
Graphics card	Hardware acceleration for DirectX 11 Dedicated memory 512 MB or more
Network card	Gigabit Ethernet, support for jumbo frames (9014 Bytes)
USB ports	USB 2.0 (1 per MVN Awinda system, 1 per license dongle)

MVN System	
Number of trackers per suit configuration:	
Full body	17 inertial motion trackers
Extra prop /backup	1 inertial motion tracker
Optional extra trackers:	3 inertial motion trackers
Total usable prop trackers	4 inertial motion trackers
MVN Camera	Prosilica GS650
MVN Mounting Straps	Fabrifoam with Velcro closure
Full body Lycra suit:	Light weight revolutionary stretch fabric with exterior zippered channels for trackers and wires
Sizes:	Straps one size fits all, with 3 sizes of vests (s-m, m-l, l-xl). Suit: S, M, L (standard), XL, XXL
Accessories:	2 gloves with tracker pocket 1 head band with tracker pocket 2 foot pads with Velcro patch Pair of shorts (MVN Link)
MVN Link on body cabling:	1 cable connects Body Pack to Battery Back, all remaining strings of trackers connect to Body Pack.
Data control units:	1 Body Pack
Power (BP)	
Battery	Part number: NC2040xx31 (3.1Ah) rechargeable smart Lithium Ion battery pack
Battery charger (included)	Part number: CH5000 battery charger with ability to recalibrate fuel gauge on battery packs
Battery charger power adapter (incl.)	Part number: ATS065TP240 110-240VAC / 24VDC 2.71A (65W)
Operating time (typical)	9.5 hours
Power Awinda Station/Charger Power adapter (incl.)	Power adapter Mean Well GE18I12-P1J 90-264VAC /12VDC 1.5A (18W)

Communication			
Interface	Wireless (WiFi or Awinda Protocol)		
Wireless range radius (max)	MVN	Awinda Station	Awinda dongle
Outdoor	150 meter (492 ft.)	~50m (164 ft.)	~20m
Indoor open space	150 meter (492 ft.)	~20m ( )	~10m
Indoor office	50 meter (164 ft.)	~20m ( )	~10m

Wireless receiver units:	MVN Link	MVN Awinda
Number of Wireless Receivers	1 Access Point	1 Awinda Station or Awinda Dongle
RF technology	WiFi 2.4GHz, 5.0 GHz	IEEE 802.15.4 PHY 2.4GHz
Interface	Ethernet	USB 1.1 or 2.0
Power	Battery	USB (station additionally mains power supply)

Physical		
Dimensions MTx	36 x 24.5 x 10mm	
Dimensions BP	160 x 72.5 x 25 mm	
Dimensions MTw	47 x 30 x 13 mm	
Dimensions Awinda Station	148x104x61.9 mm	
Dimensions Awinda Dongle	45x20.4x10 mm	
Dimensions Awinda Dongle ANT	148 x 104 x 62 mm (excluding antenna)	
Dimensions MVN suitcase	559 x 351 x 229 mm (22 x 13 x 9 inches) Flight case with wheels & extendable handle. Durable & watertight	
Weight MTx	10 g	
Weight BP	150 g	
Weight MTw	16g	
Weight Awinda Station	233g	
Weight Awinda dongle	8g	
Weight MVN Suit(no trackers)	485 g	
Weight MVN Straps(no trackers)	153 g	
Weight total on-body system (with batteries and cables)	1130 g	MVN Awinda: 525 g
Shipping weight	10 kg	5.5 kg
Housing material products	PC ABS – UL 94V-0	

### Environmental

Operation environment	0 – +50 deg Celsius, non-wet
Humidity	20-80%RH NC

### Tracker Performance

Static accuracy (Roll/Pitch)	0.2 deg
Static Accuracy (Heading)	0.5 deg
Dynamic Accuracy	1 deg RMS
Accelerometer range	MTx: $\pm 160 \text{ m/s}^2$ (16 g) MTw: $\pm 160 \text{ m/s}^2$ (16g)
Gyroscope range	$\pm 2000 \text{ deg/s}$

### MVN Performance

MVN human model	MVN uses a 23 segment biomechanical model with 22 joints. Each joint is specified by statistical parameters for 6DOF joint laxity. An advanced spine and shoulder model is used that computes the kinematics of the spine and shoulder blades.
-----------------	--

### System Calibration

General	Flexible calibration scheme with instant feedback regarding the expected accuracy. Calibration can be done without assistance from a second person.
Minimum calibration time	10 seconds. Basic calibration needs only subject length, foot length.
Advanced calibration	10 – 30 seconds per additional step. Advanced subject specific calibration determines tracker alignment and/or subject specific dimensions. Calibration procedures for subjects with limited range of motion are possible.

### MVN Fusion Engine

Output	Full kinematics of each segment (position, velocity, acceleration, orientation, angular velocity and angular acceleration). MVN Animate Pro additionally provides joint angle and CoM. All at preset sample frequency (max 240Hz). Double integration of body segment accelerations allows for jumping/running (permanent floor contact is not needed).
--------	---

### MVN Fusion Engine

3D translation capture	~1% error in traveled distance (without external aiding). Advanced external contact model detects body-world contacts, to enable crawling, sitting, cartwheel etc. Various friction models (slippage etc.) are possible. <sup>8</sup> Seamless fusion with aiding technologies possible, e.g. 3D position from optical/GPS, or 2D image correspondences. <sup>8</sup>
Magnetic environment Local, permanent disturbances	Full immunity to any magnetic distortion.
Soft tissue artifacts	Minimized to ~2 degrees RMS using redundancy in measurement and biomechanical constraints.
Multiple person capture	Up to four person capturing on one pc

### MVN Analyze/Animate Software

Functionality	Easy and quick calibration Real time preview of motion capture Simultaneous recording and viewing of motion capture data Replaying and editing of previously recorded motion data
Supported export formats	.BVH -Biovision Hierarchical Data .C3D -Coordinate 3D data .FBX - FiLMBOX .MVNX - MVN Open XML format Excel - to open with MS office Excel
Sample Frequency	60 - 240 Hz (default 240 Hz)
Wireless Update Rate	20-60Hz Depending on suit configuration
Data rate	37 MB/min @ 60 Hz 74 MB/min @ 120 Hz 158 MB/min @ 240 Hz

### Legal Notice

Warranty	2 Years
MVN and Xsens are trademarks of Xsens Technologies B.V.	
Patents Pending	
<a href="http://www.xsens.com">www.xsens.com</a>	

<sup>8</sup> Some features are only available in SDK, ask for possibilities.



**Package Label**

ORIGIN ID: LEYA 0889736700  
Customer Service  
Xsens Technologies B.V.  
Pantheon 6a

ENSCHEDÉ, 7521  
NETHERLANDS, NL

Ship Date: 28NOV17  
TotWgt: 26.10 KG  
CAD: 105422296/NET3920  
ex-EORI: NL822644186B01  
Dims: 56x35x23 CM  
BILL SENDER  
EIN/VAT:

TO

861050868318

**FedEx**  
Express



AWB



**YT AOGA**

PKG TYPE: CUSTOMER

TRK# 7708 4128 1018 Form 0430  
1 of 3

AA  
INTL PRIORITY

REF: 1721414 - PO#2017-NOV06-02  
DESC1: Inertial Fullbody Mocap System  
DESC2: MVN-AWINDA-BIOMECH  
DESC3: Inertial Fullbody Mocap System  
DESC4:

COUNTRY MFG: NL NL NL  
CARRIAGE VALUE: 0.00 EUR  
CUSTOMS VALUE: 754732.00 EUR

SIGN: Customer Service  
T/C: S 381548775  
D/T: R

For all com modities, technology or software previously exported from the United States, this was done in accordance with the Export Administration Regulations. Diversion of these items contrary to U.S. law or any other applicable country's law is prohibited.  
The Montreal or Warsaw Convention may apply and will govern and in most cases limit the liability of Federal Express for loss or delay of or damage to your shipment. Subject to the conditions of the contract on the reverse.

FEDEX AWB COPY - PLEASE PLACE IN POUCH

## 23.13 System block diagrams

### 23.13.1 MTw

The purpose of the MTw wireless motion tracker is to give accurate orientation data. This is done by sampling digital sensors and processing this data at an MCU (Microcontroller unit) to angular velocity, acceleration, magnetic field and barometric pressure information.

The MTw functions as a slave in a wireless network. It transmits the data by the RF front end (CC2541 + CC2590) wireless via AWINDA™ protocol to the AWINDA master.

The MTw power supply is a 150mAh LiPo battery, and is rechargeable on the AWINDA master. The charging circuit is integrated in the MTw. It is also possible to power and communicate with the MTw via a micro USB connector.

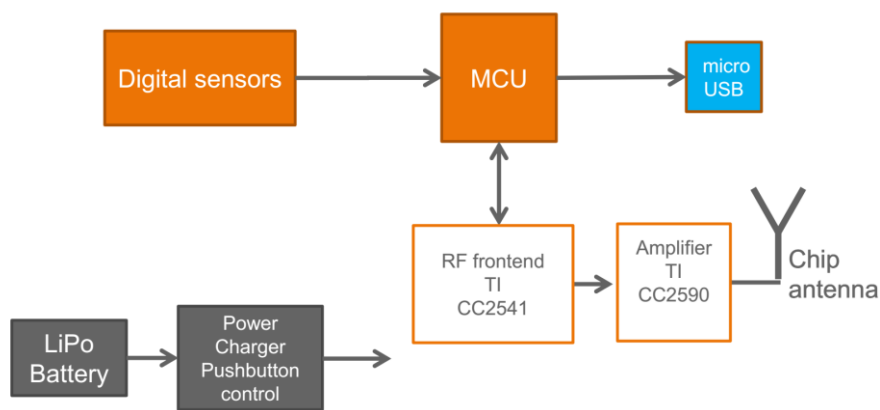

Figure 95: MTw block diagram

### 23.13.2 Awinda Dongle

The AWINDA dongle works as a master and together with the MTw it forms a wireless motion tracker system. The AWINDA dongle communication is based on CC2541 hardware, using a proprietary TDMA (Time Division Multiple Access) AWINDA™ protocol.

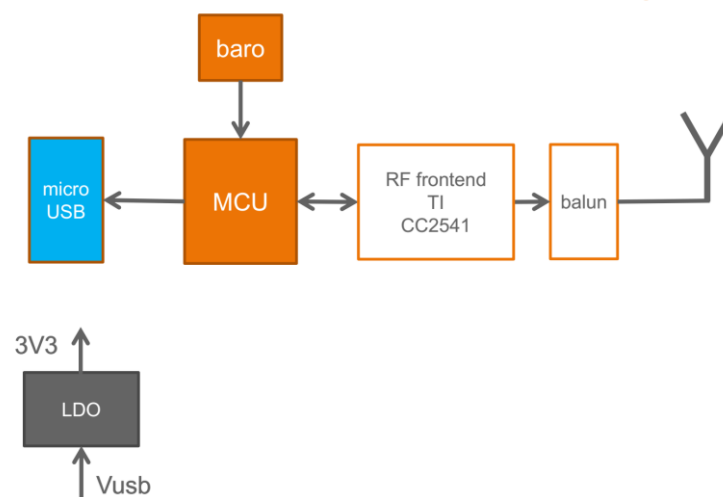

Figure 96: Awinda Dongle block diagram

### 23.13.3 Awinda Dongle ANT

The AWINDA dongle works as a master and together with the MTw it forms a wireless motion tracker system. The AWINDA dongle communication is based on CC2541 hardware, using a proprietary TDMA (Time Division Multiple Access) AWINDA™ protocol.



Figure 97: Awinda Dongle ANT block diagram

### 23.13.4 Awinda Station

The AWINDA station works as a master in a Local wireless sensor network. Together with the MTw it forms a wireless motion tracker system. The AWINDA station communication is based on a fixed channel proprietary radio 1Mbps GFSK radio (CC2541 & CC2591), using a proprietary TDMA (Time Division Multiple Access) AWINDA™ protocol. Synchronization with external devices is possible via galvanic isolated BNC ports. The AWINDA station can be powered via USB. In addition, a 12V net adapter can be connected to charge six MTw's.

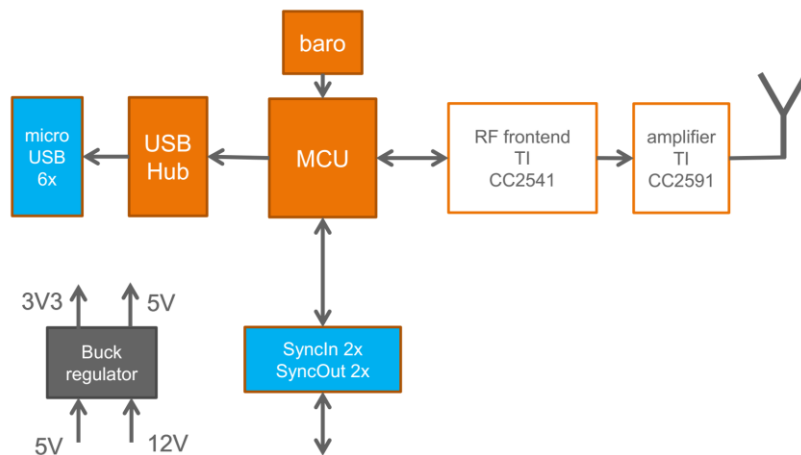

Figure 98: Awinda Station block diagram

## 24 Contact point editing

For examples of contact point editing please check this link: <https://base.xsens.com/hc/en-us/articles/360013009559-Contact-Point-editing>

## 25 Synchronization with External Devices

### 25.1 The Hardware

MVN Awinda uses the Awinda Station for synchronization.

Details on initializing the synchronization of MVN are provided in Section 7.2.9. The purpose of this section is to provide some in-depth information about the synchronization possibilities.

The Awinda Station was originally created as a wireless master to control the Xsens MTw kit. The Awinda Station and Sync Station were created specifically for the biomechanics market, where synchronization with external devices is an essential aspect of biomechanics research. For this reason, these Stations are equipped with 4 BNC connectors, two for receiving TTL pulses (Sync IN) and two for sending TTL pulses (Sync OUT).

The hardware clock of the Awinda Station is very accurate. As an indication of the clock accuracy, the error in the Awinda Station's clock has a maximum of 1  $\mu$ s every second (1 ppm). Therefore, in general, the recommended scenario is that users relying on very tightly coupled synchronization use MVN Awinda, and use it with the Sync Out settings.

With MVN Link, there is additional hardware making synchronization possible, this is software synchronization. It is essential that the user understands that software controlled synchronization can lead to undefinable latencies between button click in the software and reception of this signal.

Note that to synchronize with external devices, BNC connectors are required at the Awinda Station or Sync Station side. Since there are a multitude of system-specific connectors for third party systems, Xsens does not provide the cables or connectors. Please contact the respective third party providers or user manuals for details their hardware requirements.

#### 25.1.1 Important note when receiving 5V synchronization pulses

On the back of the Awinda and Sync Stations are four BNC ports, two Sync In ports and two Sync Out. The ports have been configured to send (Sync Out) or receive (Sync In) TTL pulses 0-3.3V.

This 3.3V is lower than the voltage sent by some devices, which will be synchronized with the MVN System. These other devices are based on 5V TTL levels. For this reason, it is advised to separately purchase (from eg Farnell) a 3.3 - 5V / 5V - 3.3V SMD level translator. This will prevent damage to the SyncIn ports of the Awinda or Sync Station when receiving 5V pulses from external systems. In general, sending a 3.3V pulse from an Awinda or Sync Station SyncOut port is fine. Therefore, unless a threshold of 5V of the third party system is required, in which case the 3.3V-5V SMD level translator will be required.

## 25.2 Sync In

Sync In means that an external device sends a control signal to the Awinda Station. The Awinda Station can detect polarity changes on the input lines. This trigger may be a rising or falling edge as illustrated in the following figures:

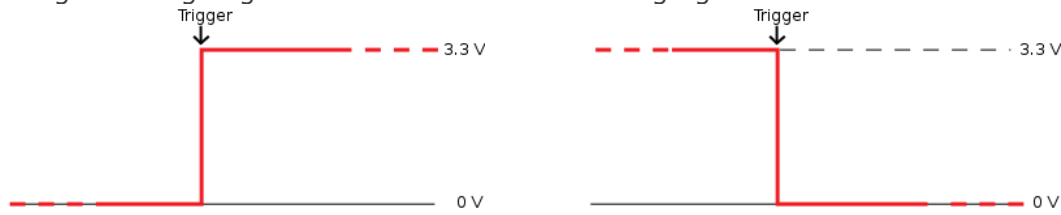

When a trigger is detected on one of the input lines, the Awinda Station can be configured to perform a certain action. Combinations of any of the following are possible on each Sync In port:

Sync Type	Description
Start Recording	External system sends a start recording trigger. Upon receiving this trigger, the Awinda Station will begin recording at the start of the first frame following the trigger.
Stop Recording	External system sends a stop recording trigger. The Awinda station will stop recording at the end of the current frame.

A number of parameters can be set for each action:

Parameter	Description
Sync Line	The sync line to activate.
Pulse Polarity	Rising or falling edge, or rising and falling.
Trigger Once	Only the first trigger event will be used. It is not recommended to select Trigger once, if more than one recording using synchronization of multiple systems will be made. This is a failsafe option in the case external systems send pulses throughout recordings.
Skip First	The number of initial occurrences of the sync trigger to skip. This is useful if a well-defined delay is expected, or if the external signal uses the same sync line to generate for example start and stop recording. If both start and stop are on the same sync line, skip first should be 1 for stop recording, ensuring that the second trigger, instead of the first, causes the recording to stop.
Skip Factor	The number of occurrences of the sync trigger to skip in between trigger signals. In the same way that was described in Skip First (above), skip factor, for start and stop recording on one sync line should be set to 1, to ensure that the first trigger starts the recording and the second stops etc.

**Note: If the user selects Sync In but selects a function from the drop-down menu that is only available as Sync out (namely, settings other than start or stop recording), the software will automatically change the sync channel to Out 1.**

Therefore, care is required when matching sync in or out with the functions available.

## 25.3 Sync Out

Sync Out is the command that enables the Xsens system to send a trigger pulse for synchronization purposes. A control signal is sent via the Awinda/Sync Station, from MVN Analyze/Animate to the third party hardware.

Sync Type	Description
Start Recording	Upon clicking the record button in MVN Analyze/Animate, the Awinda Station starts the recording and consequently sends a start recording trigger to the external system.
Stop Recording	Upon clicking the record button in MVN Analyze/Animate, the Awinda Station stops recording and sends a stop recording trigger to the external system.
Go to Operational	A Sync Out trigger on "Go to Operational" is meant to be used for setting the initial signal level on a sync out line. <b>Note: in general, this functionality is not needed since the level is automatically adapted based on the input settings.</b>
Interval Transition Measurement	A frame / or interval transition at the Station can be used to give a signal to the external system, indicating the end of the strap-down integration interval over which data is calculated. Selecting this option, the frame transition is sent from the moment that "Start Measuring" is selected.
Interval Transition Recording	See Frame transition Measurement Selecting this option, the frame transition is sent from the moment that a recording is started, which can be used by the external device to capture the timing of the recording in its local time.

A number of parameters can be set for each action:

Parameter	Description
Sync Line	The sync line to activate.
Pulse Polarity	Positive (where the polarity is initially low [0V] and goes high [3.3V]). Negative (where polarity is initially high [3.3V] and goes low [0V]).
Trigger Once	Only the first trigger event will be sent. It is not recommended to select Trigger once, if more than one recording using synchronization of multiple systems will be made.
Skip First	Number of initial sync pulses to skip. This command is useful if a well-defined delay is expected between the Xsens and the third party system. It may also be needed if the third party, like the Xsens system uses the same pulse properties to trigger different actions. See description provided above for Sync In.
Skip Factor	Number of sync pulses, between the sync pulses delivered, to skip. See Sync In Table description.
Pulse Width	The duration of the pulse in ms. Some systems wait for a signal of a minimum pulse width before generating the desired synchronization action. The Awinda / Sync Station can send a pulse with a duration of up to 99ms to a third party system. It is not recommended to send a signal longer than a frame width. Specify 0 ms to generate an infinite pulse width.

### 25.3.1 Settings in MVN Analyze/Animate

By opening the motion capture configuration window and select sync station configuration (Figure 99)

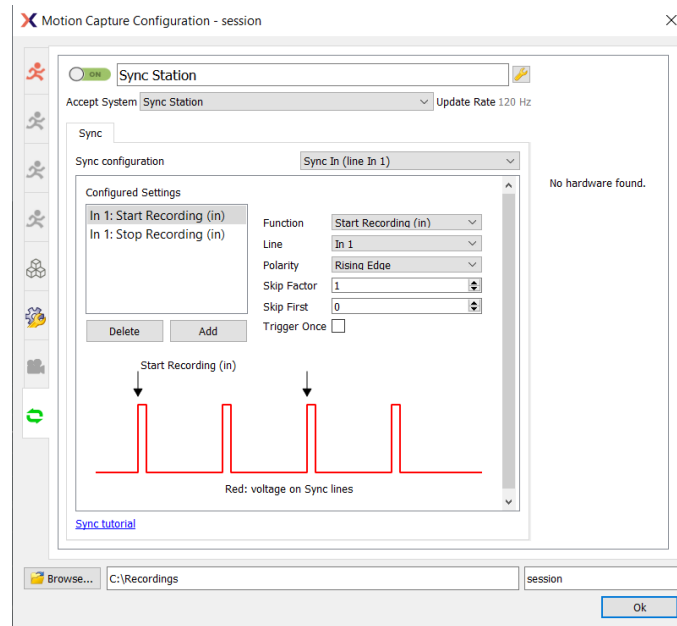

Figure 99: Sync settings window in MVN Analyze/Animate

To add a synchronization type, click "Add", all settings become available, to be set manually or using the drop down menus.

An example and the how to set up a 3<sup>rd</sup> party sync is explained in the tutorial video and base article below.

<https://tutorial.xsens.com/video/setting-up-a-sync-station/>

<https://base.xsens.com/hc/en-us/articles/115003818654-MVN-Analyze-Synchronization-Options-TTL>

## 25.4 Important Notices for Sync In

When the Awinda Station is configured to start recording upon receipt of a trigger, it initializes recording at the start of the following frame. The Awinda Station cannot trigger a start recording command between frames since data received in a given frame is measured in the previous one. Therefore, delaying the recording in this way ensures that data is not recorded prior to the external trigger indication.

In the same way, recording should not be stopped between frames, since data received in a given frame was measured during the previous frame. Therefore, the Awinda Station stops recording immediately after the current frame.



### 25.4.1 Sync In Recommended Settings

Note that the preferences menu includes "Skip first" and "Skip Factor". The definitions of these have been provided above; however for practical use consider the following: When the Awinda Station is triggered to start and stop a recording, on one line, it will blindly receive 3.3 V pulses on that line. Since all pulses are the same, the Station requires further instructions about what to do with each pulse. In the software, a translation has been put in place to carry out a certain action with each pulse.

Therefore, to start a recording, one must give an initial pulse. The second pulse, should indicate a stop recording, therefore the skip factor in "Start Recording" should be set to 1. In Stop Recording, the first pulse should not trigger a stop (it was just used to Start Recording); so a Skip First of 1 must be input, and to ensure that every other pulse thereafter stops the recording, a Skip Factor of 1 must be input.

This means that Start Recording is commanded on pulse 1, 3, 5 etc and stop recording on 2, 4, 6 etc.

### 25.5 Sync In with MVN Analyze/Animate

When Sync In is in use, after configuration, and when ready to record, users should click Record, to prepare the system for the external trigger. The record icon changes from the normal red dot to one with the pause symbol overlaid. When recording has been triggered by the external system, the record button will indicate as such (most right icon shown below):

		
Record button prior to depression	Record button when depressed and waiting for Sync In signal	Record button during recording (and temporarily during flushing)

### 25.6 Sync Out with MVN Analyze/Animate

When the parameters have been set for MVN Analyze/Animate to control the start and stop of recordings, each time the record button in MVN Analyze/Animate is depressed, a TTL pulse will be sent to the specified Sync Line. The receiving system must be configured to take the specified action.

Of course, ensure that the BNC connector is connected to the correct Sync Out line(s).

### 25.7 3<sup>rd</sup> party Synchronization Examples

Xsens tried and tested with a number of third party hardware systems, an overview can be found [here](#).

EMG	Pressure Mats	Optical Systems	EEG	Data Loggers
Noraxon Delsys Cometa Wave TMSi BTS	GAITRite	Vicon Qualisys	TMSi ANT Neuro	DataLOG

### 25.8 Network sync

<https://base.xsens.com/hc/en-us/articles/360012651559-Network-Sync-in-MVN-2020-0>

## 25.9 Gloves

Manus: <https://base.xsens.com/hc/en-us/articles/360017254919-Setting-up-Manus-Prime-2-Gloves-with-MVN>

StretchSense: <https://base.xsens.com/hc/en-us/articles/360017745539-Streaming-StretchSense-Glove-Data-into-MVN>

## 26 References

---

- <sup>i</sup> Wu G, Cavanagh PR (1995). ISB recommendations for standardization in the reporting of kinematic data. *J. Biomech.* 28: 1257-261
- <sup>ii</sup> Wu G., Siegler, S., Allard, P., Kirtley, C., Leardini, A., Rosenbaum, D., Whittle, M., D’Lima, D., Cristofolini, L., Witte, H., Schmid, O., Stokes, I., (2002). ISB recommendation on definitions of joint coordinate system of various joints for the reporting of human joint motion—part I: ankle, hip, and spine. *J. Biomech* 35:543–548
- <sup>iii</sup> Wu G, van der Helm FC, Veeger HEJ, Makhsous M, van Roy P, Anglin C, Nagels J, Karduna A, Mc Quade K, Wang X, Werner FW, Buchholz B (2005) ISB recommendation on definitions of joint coordinate systems of various joints for the reporting of human joint motion—part II: shoulder, elbow, wrist and hand. *J Biomech* 38:981–992
- <sup>iv</sup> Della Croce U, Leardini A, Chiari L, Della Croce A. (2005) Human movement analysis using stereophotogrammetry. Part 4: assessment of anatomical landmark misplacement and its effects on joint kinematics; *Gait & posture*; vol. 21, no2, pp. 226-237
- <sup>v</sup> Šenk M, Cheze L. (2006) Rotation sequence as an important factor in shoulder kinematics. *Clinical Biomechanics* 21 S3 S8
- <sup>vi</sup> Grood, E.S., Suntay, W.J., (1983). A joint coordinate system for the clinical description of three-dimensional motions: application to the knee. *J. Biomechanical Engineering* 105:136-144